

# Warmup®

The world's **best-selling** floor heating brand™



*TTA Award Winner 2016:  
Best Innovation*

**4iE**® SMART WIFI  
THERMOSTAT

For central and underfloor heating

**The right temperature. The best tariff. Effortlessly.**

# Table of Contents

Why Warmup®	Page
System Summary Guide	3
Warmup's Unique Product Advantage and the Best Warranties, Installation Guarantee and Accreditations	4-5
About Warmup and our Services	6-7
World Leading Research and Development	8
Benefits of Underfloor Heating	9
Warmup® Electric Floor and Wall Heating	Page
4 Easy Steps to Calculate your Underfloor Heating Requirements	10-11
Heating Systems	12-31
Warmup® Cement Coated Tough Insulation Boards	32-35
Warmup® Insulated Underlay/Dual Overlay	36-39
Warmup® Electric In-Wall Heating Panel	40-41
Thermostats	Page
Warmup® Smart Introduction	43
Warmup® 4iE Smart WiFi Thermostat	44-47
Warmup® 4iE+Kit	48-49
Warmup® 3iE Energy-Monitor Thermostat	50-53
Warmup® Tempo Digital Thermostat	54-55
Bathroom	Page
Warmup® Mirror Demisters	56-57
Warmup® Electric Towel Rails	58-59
Outdoor Heating Solutions	Page
Snow Melting Cables	60
Self-Regulating Cable	61
Patio Heaters	62
Warmup® Hydronic Underfloor Heating	Page
Warmup® Hydronic Underfloor Heating Systems - Introduction	64
Warmup® Manifold	66-69
Warmup® HydroPack Installation Kit	70-73
Hydronic Systems - Screed and Concrete Floors	74-83
Hydronic Systems - Timber, Suspended and Batten Floors	84-91
Hydronic Systems - Total-16 Low Profile System	92-93
Warmup® Dual Overlay Concrete	94-95
Thermostats and Controls	96-98
Insulation, Routed Boards and Ancillaries	99-103
Fixings and Ancillary Products	104-106
Manifolds, Ancillaries and Fittings	106-107
Pipes	109
Global Projects Division	Page
Global Projects Division: A Dedicated Service	111-114



# System Summary Guide

Whatever the floor finish or subfloor construction, Warmup has the right underfloor heating solution to match your specific needs. Use the table below to find out which products best suit your floor type. Contact us on 0345 345 2288 should you require further information.

		Warmup Electric Products					Warmup Hydronic Products	
		DCM-PRO	Loose Wire	Sticky Mat 150 Watt	Sticky Mat 200 Watt	Inscreed Cable		Foil Heater
Page Number		12	16	20	20	24	28	64
FLOORING TYPE	Tile & Stone	✓	✓	✓	✓	✓		✓
	Hardwood	✓				✓	✓	✓
	Laminate	✓				✓	✓	✓
	Carpet	✓				✓	✓	✓
	Vinyl	✓				✓	✓	✓



Call us on **0345 345 2288** to discover how we can help or chat with us online at [www.warmup.co.uk](http://www.warmup.co.uk)

Warmup is fully tested and compatible for use with wood floors and vinyl including leading brands like:



# Warmup's Unique Product Advantage



## Electric

**Warmup® offers the thinnest dual-fluoropolymer coated multi-strand heating wire (less than 1.8mm in diameter) on the market** - to enable you to offer your customers the very best solution. **It will not raise floor levels** and is BEAB approved, meeting the highest safety standards. Best of all, it is quick and easy to install.

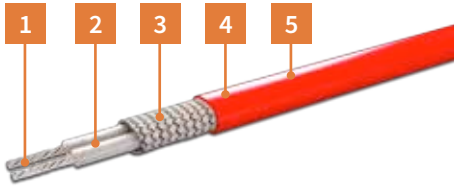

1. Multi-strand twin conductors/heating element
2. Inner Insulation: advanced fluoropolymer
3. Earth Braid
4. Diameter 1.8mm
5. Outer Insulation: advanced fluoropolymer



## Hydronic

### Warmup® offers you a complete bespoke solution

Warmup® hydronic heating systems come fully designed and supplied with a full set of high quality components and controls ready for installation. Systems are available in a number of configurations and components guaranteed to perfectly match your project and budget.

Warmup systems come with a choice of 3 pipe types; PEX-A, PE-RT and PE-RT/AL/PE-RT. This choice guarantees that you have the best possible system, tailored to your specific installation and budget.

Warmup® PEX-A hydronic pipe carries a Lifetime Warranty for greater peace of mind. All other pipes carry a 50 year Warranty.



# The Best Warranties, Installation Guarantee and Accreditations

Warmup® Loose Wire, StickyMat, PEX-A Systems carry a **Lifetime Warranty for greater peace of mind.**



**A Lifetime Warranty upgrade is available on the 4iE Smart WiFi Thermostat, 3iE Energy-Monitor Thermostat and Tempo Digital Programmable Thermostat.**

\*Visit [www.warmup.co.uk](http://www.warmup.co.uk) for details

## SAFETY Net™ Installation-Guarantee

If you accidentally damage the heating system during installation, return it to Warmup and we will replace it with another heater of the same make and model FREE!

(See [www.warmup.co.uk](http://www.warmup.co.uk) for full details)



Intertek



Rest assured, you are installing the very best. **Warmup is the only underfloor heating company** whose products are European compliant, CE marked and accredited by all these independent institutions. In addition, we are members of BEAMA, CIBSE, RIBA, and TTA.



FS 586320

**17<sup>th</sup> Edition Approved.** All Warmup products comply with 17<sup>th</sup> Edition of the **IET Electrical Requirements BS7671**

# About Warmup®

Warmup® is a certified ISO 9001:2008 UK based manufacturing Plc creating and delivering underfloor heating solutions (electric, hydronic and hybrid - a mixture of both). We have sold in excess of 2 million systems in more than 65 countries in over 20 years of trading. We have subsidiary operations in 11 countries and licensed trading partners in the other countries.

The combination of Warmup's heating wire with fluoropolymer coatings (on the inner wires and the outer protective jacket), our 4iE® Smart WiFi Thermostat, 3iE® Energy-Monitor Thermostat and Tempo Digital Programmable Thermostat are patented, trade mark protected designed and owned by the world's best selling floor heating brand.

We began as, and remain, a knowledge and research driven UK business, making proprietary world-leading products.

Warmup has a tradition for quality and innovation. We constantly update and add to our product range to deliver the absolute best products.

Warmup is the only underfloor heating company whose products are European compliant, CE marked and accredited by more independent institutions than anyone else in the industry, giving you and your customers security and peace of mind.



## Our Services

We are with you every step of the way. Since 1994, Warmup has provided trade professionals with outstanding services and quality products through leading retailers, wholesalers and builder merchants. This includes:

### Unique Online “Quick Quote” Service

Let us save you time by calculating the right product, price and size required for your project. All you need to do is visit our website, enter a few project details for a no-obligation “Quick Quote”. You will receive a quotation estimate within a few minutes. Should you require a more detailed quotation, you can submit your drawings or plans to [www.warmup.co.uk](http://www.warmup.co.uk) or via fax on 0345 345 2299.

### Technical Helpline

We are the **only company** who offers a technical helpline 24/7/365. If you have a question or an installation problem, our experienced Technical Team are available to support you - call 0345 345 2288. We also offer online ‘live’ chat and a host of installation tutorials - [www.warmup.co.uk](http://www.warmup.co.uk)

## Repair Kits

Minor damage (i.e. nicking the electric wire with a trowel), discovered before the floor is laid, can easily be repaired on-site. Call 0345 345 2288 to obtain an easy-to-fit repair kit, via next-day delivery (or keep a few extra available).

## Running Cost Information

To get an accurate idea of typical running costs of a Warmup System, see the table below.

	2m <sup>2</sup>	4m <sup>2</sup>	5m <sup>2</sup>	10m <sup>2</sup>	15m <sup>2</sup>	25m <sup>2</sup>
1 hr	2.36p	4.72p	5.90p	11.81p	17.71p	29.52p
2 hrs	4.30p	8.61p	10.76p	21.52p	32.28p	53.81p
3 hrs	6.25p	12.49p	15.62p	31.23p	46.85p	78.08p
4 hrs	8.10p	16.20p	20.26p	40.51p	60.77p	101.28p
5 hrs	10.13p	20.26p	25.32p	50.64p	75.96p	126.60p
6 hrs	11.94p	23.89p	29.86	59.72p	89.59p	149.31p
7 hrs	13.93p	27.85	34.82p	69.63p	104.45p	174.08p
8 hrs	15.83p	31.66p	39.57p	79.15p	118.72p	197.87p

Financial figures in UK pence

**Notice:** Any unauthorised replication of this material, including running cost data, will constitute an infringement of copyright.

## Rapid Delivery

If you need products quickly, ask your supplier to place your order by 4.30pm, Monday-Friday and we will ship it the same day for next-working-day delivery (allow 2-3 days for Scotland and the Channel Islands). Warmup is fully stocked and available from leading retailers and trade outlets, throughout the UK.

## Warmup® Service Engineers

Should your customer's heating system become damaged after installation, we offer a team of experienced service engineers, who will identify and correct the damage. Call Warmup on 0345 345 2288 to arrange an appointment.

## Quotation & Layout Service

Warmup offers a FREE CAD drawing and quotation service to all customers, regardless of project size. All you need to do is fax your drawing to 0345 345 2299, email [uk@warmup.com](mailto:uk@warmup.com) or visit [www.warmup.co.uk](http://www.warmup.co.uk) to access our quotation facility and Warmup will do the rest.

## Training

Warmup provides group training sessions for any sized project, held at our Head Office in London. Let our trained professionals show you how quick and easy it is to install Warmup with no need for specialist trades. It's FREE - why not upgrade your skills and stand out from your competitors? Call 0345 345 2288 or email [training@warmup.com](mailto:training@warmup.com) for details.

# World Leading Research & Development

By continually investing in research and development, Warmup® is able to foresee and respond to upcoming industry trends and technological developments. This guarantees you fast access to the latest innovations when it comes to underfloor heating design, energy efficiency and reducing CO<sup>2</sup> emissions.

## Warmup® Monitored Family Homes Programme

In support of our EN442-2 Research Centre in Germany, we operate a number of Family Monitored Houses in addition to the BRE (Building Research Establishment) Renewable House.

This initiative grew out of the need to better predict the future energy running costs of houses using Warmup underfloor heating systems. Information is gathered every few minutes from many tiny sensors.

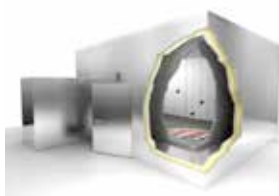

Bi-climatic chamber in Warmup's Research Centre in Germany

These sensors are strategically placed in each zone to compare floor, wire/water and outside temperatures and often other readings like humidity and radiant temperature. This allows a detailed view of the amount of energy actually needed to create ideal living conditions.

This can be compared with test facility results and in particular, what may have been predicted by SAP (Standard Assessment Procedure) calculations, which are central to the perceived energy performance and efficiency of a dwelling.

This information allows us to answer questions from 'How much will it cost to run Warmup in my new house?' to 'How much will I save using Warmup underfloor heating rather than radiators in my home?'

## How much does underfloor heating cost to heat my room?

RUNNING TIME				
ROOM TYPE	HEATED AREA	AM	PM	WINTER COST*
Bathroom	4m <sup>2</sup>	2hrs	1hr	£24.26
Kitchen	5m <sup>2</sup>	1hr	2hrs	£30.33
Lounge	15m <sup>2</sup>	0hrs	3hrs	£85.27

\*Assumptions: 12.66p/kWh - system on 6 months (182 days) per year. System installed on 10mm Warmup® Insulation Board. \*\*Avg. running cost after initial heat-up period = 0.85p/m<sup>2</sup>/hr.  
For more details visit [www.warmup.co.uk](http://www.warmup.co.uk)



# Benefits of Underfloor Heating

Floor heating is simply the only way to create the ideal comfort zone in a family room to balance floor and air temperature.

**Suitable for every type of project** - new-build, refurbishments and renovations.

**Appropriate for use under a wide range of floor finishes** - stone, tile, wood, carpet and vinyl.

Warmup is fully tested and compatible for use with Karndean and Amtico.

With its low operating temperature, warmth is evenly spread across the whole floor area, with no cold spots, heating from the floor upwards without creating a stuffy atmosphere.

**Energy efficiency** - underfloor heating gives the user control, provides rapid heat-up and high efficiency heating. It requires significantly less energy as you are not heating the ceiling area and it enables the temperature to be accurately controlled as needed, allowing end users to heat the room(s) they want, with no energy wasted.

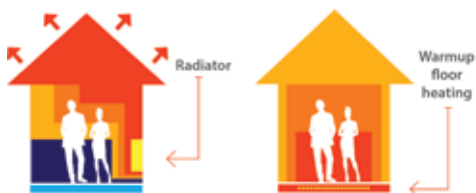

**Temperature control in each zone** - comprehensive range of thermostats, including the 4iE® Smart WiFi Thermostat, allows the end user to choose the temperature levels they require, with programmable settings (heat on/off) to match their lifestyle.

**Cost savings** - because underfloor heating uses a lower temperature than standard radiators, heating costs are reduced and savings can be achieved by at least 10% on utility bills.

**Design freedom** - underfloor heating means no bulky radiators to take up valuable wall and floor space.

**Safety** - delivers a family-friendly and safe environment. No low level hot surfaces or hard metal edges that come with a radiator system, creating a potentially unsafe and dangerous environment for small children, the elderly or people at risk.

**No maintenance** - there is no maintenance required for electric underfloor heating and little or no maintenance required on our hydronic systems.

**Hydronic underfloor heating can be linked to most heat sources, giving total flexibility** - allowing for best energy savings as new energy efficient heat generators become available, now and in the future.

# 4 Easy Steps to Calculate your Underfloor Heating Requirements for Electric Systems



To calculate the underfloor heating system(s) you require for your room(s), you need to determine the working floor space available to you. This is the total amount of floor space less the area taken up by any fixed objects, i.e. kitchen units, bath etc. You only need to heat the area you will be walking on.

**We would recommend that you allow a 5 centimetre (2 inch) gap between the walls and the area where you intend to install the heating system.**

## Step 1

*Measure your room dimensions*

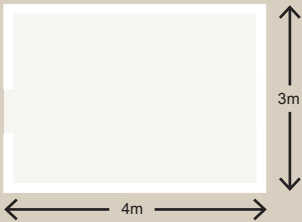

**Work out the total floor area.** If the overall room is rectangle in shape, say 4m by 3m – all you need to do is multiply both numbers – which gives you 12 sqm.

## Step 2

*Disregard any area taken up by furniture*

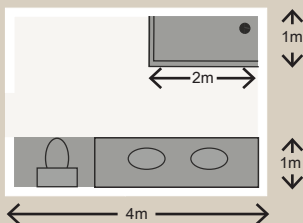

**Work out how much of the floor space is taken up by fixed objects, i.e., in your kitchen** – start with the big items and finish with small items. For example, assume you have kitchen floor units 600mm in depth x 3m long; a free standing fridge, 600mm x 600mm. You need to calculate these areas i.e,  $0.6\text{m} \times 3.0\text{m} = 1.8\text{ sqm}$  and  $0.6\text{m} \times 0.6\text{m} = 1.2\text{ sqm} = \text{Total area } 3.0\text{ sqm}$ .

## Step 3

*Determine the floor area to be heated*

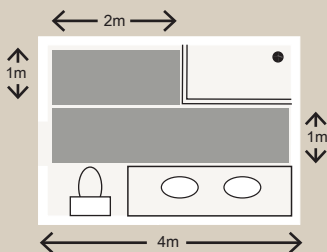

From Step 1 and Step 2 you now know the amount of fixed space: Step 1: 12 sqm Step 2 = 3 sqm.

## Step 4

*Select the heating system of choice*

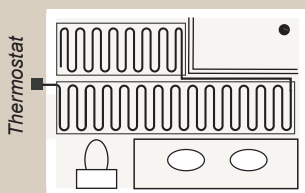

Now calculate the amount of free floor space for your Warmup cable or mat:

Floor space =  $12\text{ sqm} - 3\text{ sqm} = 9\text{ sqm}$ . **Therefore, 9sqm is what you require from your chosen Warmup system.**



# Warmup® DCM-PRO

## NEW!

*The DCM-PRO is the fastest way to install a heated decoupling system in all areas; in fact 40% faster than standard underfloor heating membranes. The patent pending self-adhesive underside acts as a self-healing decoupling layer and eliminates the need for an adhesive layer, reducing both time and costs.*

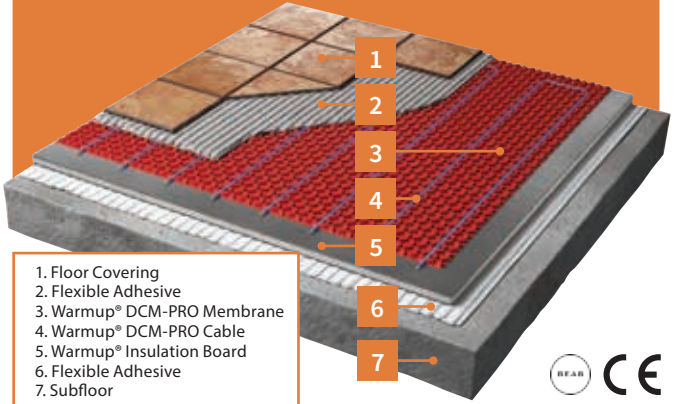

1. Floor Covering
2. Flexible Adhesive
3. Warmup® DCM-PRO Membrane
4. Warmup® DCM-PRO Cable
5. Warmup® Insulation Board
6. Flexible Adhesive
7. Subfloor



Technical Data Mat	Technical Data Cable
<b>Thickness:</b> 5.5mm	<b>Operating voltage:</b> 220-240v:50Hz
<b>Composition:</b> Polymer	<b>Cable thickness:</b> 4.5mm
<b>Spacing:</b> 60/90/120mm	<b>Average output rating:</b> 150 W/m <sup>2</sup> (3 Castellations - 90mm)
 <b>SAFETY Net™</b> Installation-Guarantee	<b>Inner/Outer wire insulation:</b> Advanced fluoropolymer(ETFE)/PVC
	Single 3m long 'cold tail' connection lead
	<b>IP Rating:</b> IPX7
	<b>Approvals:</b> BEAB
	Lifetime Warranty & SafetyNet™ Installation Guarantee

## Frequently Asked Questions

### Can the DCM-PRO system reduce the risk of my tiled floor developing cracks?

As a decoupling system, the DCM-PRO has been designed to absorb the normal lateral movement which occurs when the subfloor and finished floor expand and contract at different rates. This has been backed up with a 'High Performance' rating for crack isolation, as externally tested according to ANSI 118.12.5.4 (American National Standards Institute, [www.ansi.org](http://www.ansi.org)).

### How does the DCM-PRO cable fit into the DCM-PRO mat?

The DCM-PRO cable clips into the castellations of the DCM-PRO mat. No tools are required when installing the cable into the mat. It is easily installed by running your thumb along the top of the cable to guide it into the castellations.

### Do I need to use primer when installing the DCM-PRO system?

If the DCM-PRO is being laid directly onto a plywood or concrete subfloor, an SBR primer is required at a ratio of 1:4. If an insulated or standard tile backer board is being used, no primer is needed. We recommend you use Warmup insulation boards.

### How quickly can I lay floor finish onto the DCM-PRO?

Straight away. One of the main advantages of the self-adhesive properties of the DCM-PRO is no waiting time. As soon as the mat is fitted, cable installed and cable resistance checked, tiling or self-levelling can be started.

### Can the DCM-PRO system be used in a wet room?

Yes. With the addition of the DCM-PRO waterproofing tape installed following the recommended installation method, set out in the installation guide, the system is waterproof and can be used in a full wet room environment.



Installation video for Warmup® DCM-PRO  
Always refer to the installation manual prior to commencing your project.

## DCM-PRO Mat Price Guide

Product Code	Format	Length (m)	Width (m)	Area Covered (m <sup>2</sup> )	Price (Excl. 20% VAT)
DCM-M-1	Sheets	1	1	1	£16.66
DCM-M-15	Rolls	15	1	15	£249.99

## DCM-PRO Cable Price Guide

Output	230W/m <sup>2</sup>	~190W/m <sup>2</sup>	150W/m <sup>2</sup>	~130W/m <sup>2</sup>	115W/m <sup>2</sup>
Spacing	60mm	60/90mm	90mm*	90/120mm	120mm
Castellations	2	2/3	3	3/4	4

Product Code	Area Covered (m <sup>2</sup> )	Area Covered (m <sup>2</sup> )	Area Covered (m <sup>2</sup> )	Area Covered (m <sup>2</sup> )	Area Covered (m <sup>2</sup> )	Price (Excl. 20% VAT)
DCM-C-1	0.7	0.8	1.0	1.2	1.3	£95.83
DCM-C-1.5	1.0	1.3	1.5	1.8	2.0	£104.17
DCM-C-2	1.3	1.7	2.0	2.3	2.7	£125.00
DCM-C-2.5	1.7	2.1	2.5	2.9	3.3	£141.67
DCM-C-3	2.0	2.5	3.0	3.5	4.0	£158.23
DCM-C-3.5	2.3	2.9	3.5	4.1	4.7	£179.17
DCM-C-4	2.7	3.3	4.0	4.7	5.3	£200.00
DCM-C-4.5	3.0	3.8	4.5	5.3	6.0	£220.83
DCM-C-5	3.3	4.2	5.0	5.8	6.7	£250.00
DCM-C-6	4.0	5.0	6.0	7.0	8.0	£275.00
DCM-C-7	4.7	5.8	7.0	8.2	9.3	£308.33
DCM-C-8	5.3	6.7	8.0	9.3	10.7	£341.67
DCM-C-9	6.0	7.5	9.0	10.5	12.0	£383.33
DCM-C-10	6.7	8.3	10.0	11.7	13.3	£429.17
DCM-C-12	8.0	10.0	12.0	14.0	16.0	£483.33
DCM-C-14	9.3	11.7	14.0	16.3	18.7	£550.00
DCM-C-16	10.7	13.3	16.0	18.7	21.3	£625.00

\*recommended spacing

## DCM-PRO Accessories Price Guide

Product Code	Description	Length (varies)	Height (mm)	Width (mm)	Thickness (mm)	Price (Excl. 20% VAT)
DCM-E-25	Perimeter Strip	25m	30	-	10	£20.83
DCM-T-10	Waterproofing Tape	10m	120	-	1	£25.00
DCM-R-I	Internal Corner	120mm	60	120	1	£5.42
DCM-R-E	External Corner	120mm	60	120	1	£5.42

## Protects Floor from Damage

Rated as high performance, the DCM-PRO is proven to protect tiled floors from cracking (ANSI 118.12.5.4).

Unlike traditional fabric-based decoupling layers which tear upon movement, the patent pending self-healing decoupling layer contracts and expands to deal with seasonal changes, preventing damage occurring from gaps and cracks in the subfloor.



Protects floor surface from damage caused by subfloor movement.

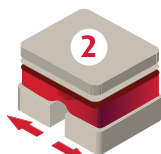

Patent pending adhesive layer slides and stretches with expansion.



Adhesive layer contracts and self-heals if gap shrinks due to seasonal changes (typical for wood subfloors).

## Convenient Sizing

- 1m<sup>2</sup> of cable fits exactly 1m<sup>2</sup> of membrane at the recommended 90mm spacing
- Can be adjusted to increase or decrease coverage and power:
  - 230 Watts per m<sup>2</sup> - based on 2 castellations
  - 190 Watts per m<sup>2</sup> - based on alternate 2 or 3 castellations
  - 150 Watts per m<sup>2</sup> - based on 3 castellations (recommended)
  - 130 Watts per m<sup>2</sup> - based on alternate 3 or 4 castellations
  - 115 Watts per m<sup>2</sup> - based on 4 castellations



# Warmup® Loose Wire System

*Warmup® Loose Wire System uses an ultra-thin dual-core heating wire that is flexible, easy to install and will not raise floor levels. Ideal for more irregular shaped areas for precise installation.*

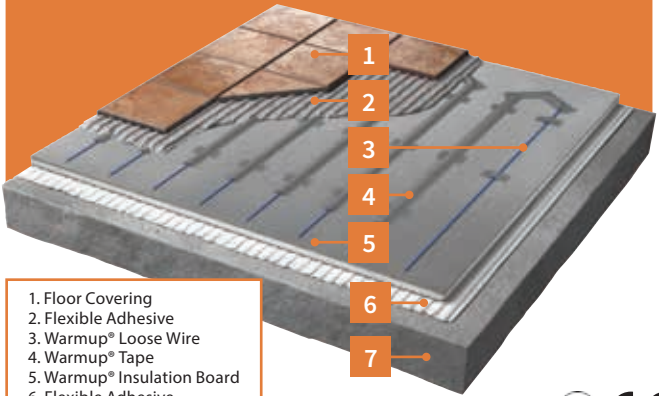

- 1. Floor Covering
- 2. Flexible Adhesive
- 3. Warmup® Loose Wire
- 4. Warmup® Tape
- 5. Warmup® Insulation Board
- 6. Flexible Adhesive
- 7. Subfloor



Features	Technical Data
Ultra-thin dual-core heating element will not raise floor levels	<b>Operating voltage:</b> 230V: 50Hz
The thinnest dual-fluoropolymer coated heating wire (less than 1.8mm diameter)	<b>Cable thickness:</b> 1.8mm
BEAB approved heating element meets the highest safety standards	<b>Average output rating:</b> 150 W/m <sup>2</sup>
Quick installation – Single connection lead for fewer steps	<b>Inner/Outer wire insulation:</b> Advanced fluoropolymer
 <b>SAFETYNet™</b> Installation-Guarantee	Single 3m long 'cold tail' connection lead
	<b>Approvals:</b> BEAB
	European compliant and CE marked
	Lifetime Warranty & SafetyNet™ Installation Guarantee



## Price Guide

Area Heated	Product Code	Wattage	Amps	Price (Excl. 20% VAT)
1.5 to 2.4m <sup>2</sup>	DWS300	300W	1.30A	£114.16
2.5 to 3.4m <sup>2</sup>	DWS400	400W	1.80A	£135.41
3.5 to 4.4m <sup>2</sup>	DWS600	600W	2.61A	£198.74
4.5 to 5.9m <sup>2</sup>	DWS800	800W	3.48A	£256.66
6.0 to 6.9m <sup>2</sup>	DWS600 + DWS400	1000W	4.41A	£847.47
7.0 to 8.4m <sup>2</sup>	2 x DWS600	1200W	5.22A	£397.48
8.5 to 9.9m <sup>2</sup>	DWS800 + DWS600	1400W	6.09A	£455.40
10 to 11.4m <sup>2</sup>	2 x DWS800	1600W	6.96A	£513.32
11.5 to 12.9m <sup>2</sup>	DWS800 + DWS600 + DWS400	1800W	7.89A	£590.81
13.0 to 14.4m <sup>2</sup>	2 x DWS800 + DWS400	2000W	8.76A	£648.73
14.5 to 15.9m <sup>2</sup>	2 x DWS800 + DWS600	2200W	9.57A	£712.06
16.0 to 17.4m <sup>2</sup>	3 x DWS800	2400W	10.43A	£769.98
17.5 to 18.9m <sup>2</sup>	2 x DWS800 + DWS600 + DWS400	2600W	11.37A	£847.47
19.0 to 20.4m <sup>2</sup>	3 x DWS800 + DWS400	2800W	12.24A	£905.39
20.5 to 21.9m <sup>2</sup>	3 x DWS800 + DWS600	3000W	13.04A	£968.72
22.0 to 25m <sup>2</sup>	4 x DWS800	3200W	13.91A	£1,026.64

\*Prices above **DO NOT** include a Warmup thermostat. (See pages 43 - 55 for details).



Installation video for Warmup Loose Wire System.  
Always refer to the installation manual prior to commencing your project.

# Installation Guide

**(Refer to installation manual for complete instructions)**

Ensure the subfloor is smooth, clean and dry. We recommend you install Warmup® Insulation Boards for energy efficiency, but if you do not, paint the floor with the Warmup primer and allow to dry. Mark the perimeter and heater spacings on the floor using the sizing guide at the back of the installation manual.

## Laying the Loose Wire System

Tape the joint to the start point on the floor and lay out the wire in parallel lines with U-shape returns. Tape and secure the heating wire to the floor with the adhesive tape provided. Ensure an even coverage with a minimum of 50mm spacing. Once completed, tape down the entire length of the heating wire.



## Connecting to the power supply

**NOTE:** All electrical connections must be performed by a certified electrician.

Chisel out channels for the power supply cable and floor sensor probe and secure with fixing tape. Wire the thermostat, following the instructions provided.

## Completing the job

Apply a full bed of flexible tile adhesive over the taped wire and tile as normal, taking care not to damage or dislodge the heating wire. Grout the floor as soon as possible and allow the adhesive to fully dry before switching on the heater.

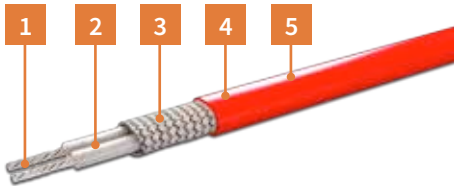

1. Multi-strand twin conductors heating element
2. Inner Insulation: advanced fluoropolymer
3. Earth Braid
4. Diameter 1.8mm
5. Outer Insulation: advanced fluoropolymer

## Frequently Asked Questions

### Can I use the Warmup® Loose Wire System as a primary heat source?

If your room is well insulated and complies with modern insulation levels you should be able to use Warmup as the sole heat source. However, if your house is an older property with lower insulation properties it is likely that an additional heat source may be required. Heat loss calculations can be carried out by a builder, architect or heating engineer.

### What type of flooring can I use over the Loose Wire System?

The Loose Wire System is specifically designed for use under tiles and natural stone. Consult the chart on page 3 - Warmup has a range of heating systems for virtually any floor finish.

### What can I do if the heater is too big for my area?

Warmup® Loose Wire gives you the flexibility to alter the wire spacing. The spacings between each run of heating element can be brought down to a minimum of 50mm and a maximum of 100mm.

**NOTE: The heating wire cannot be shortened or cut at any stage.** The correct size heater should be purchased for the floor area to be heated (e.g. the net heated area after all fixed units have been subtracted). If in doubt, call 0345 345 2288 and let our trained staff advise you.

### Should I use primer with the Loose Wire System?

If the heating element is being laid directly onto a plywood or concrete subfloor, use the primer supplied. Leave to dry for 2-3 hours until tacky, then lay the heating element. If an insulated or standard tile backer board is being used, no primer is needed. We recommend you use Warmup Insulation Boards.

### How long after installation can I turn the heaters on?

The flexible tile adhesive **must** be fully dried before the underfloor heating can be turned on. Allow a minimum of 7-10 days. Turning the system on too early can force the flexible tile adhesive to dry too quickly, causing it to crack.





# Warmup® 150W & 200W/m<sup>2</sup> StickyMat System

*Warmup® StickyMat underfloor heating system is suitable for all projects; new-build, retrofits and refurbishments. The StickyMat System consists of a thin loose wire evenly spaced and taped to a glassfibre mesh with pressure sensitive adhesive, reducing installation time by 35%, for the fastest and most secure installation method of electric underfloor heating.*

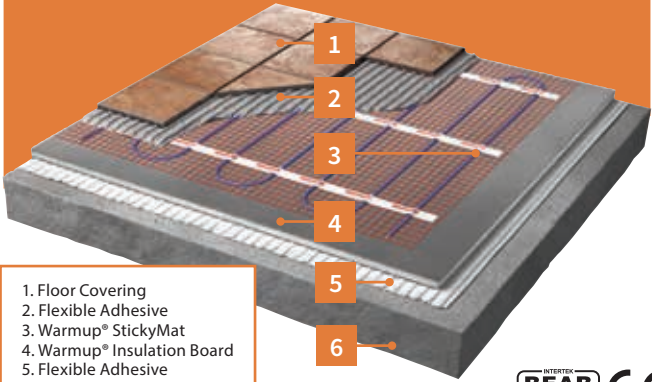

- 1. Floor Covering
- 2. Flexible Adhesive
- 3. Warmup® StickyMat
- 4. Warmup® Insulation Board
- 5. Flexible Adhesive
- 6. Subfloor



Features	Technical Data
The thinnest dual-fluoropolymer coated heating wire (less than 1.8mm diameter)	<b>Operating voltage:</b> 230V: 50Hz
StickyMat with pressure sensitive adhesive, for the fastest and most secure installation	<b>Width:</b> 500mm (0.5 metre)
Can be repositioned easily without losing adhesion	<b>Mat thickness:</b> 3mm
The pressure sensitive adhesive ensures that no wire or mesh is raised when tiling or covering with a self-levelling compound	<b>Inner/Outer wire insulation:</b> advanced fluoropolymer
 <b>SAFETY Net™</b> Installation-Guarantee	<b>Output rating:</b> 150W/m <sup>2</sup> and 200W/m <sup>2</sup>
	Single 3m long 'cold tail' connection lead
	<b>Approvals:</b> BEAB
	European compliant and CE marked
	Lifetime Warranty & SafetyNet™ Installation Guarantee

# Price Guide

## Price Guide for 150W/m<sup>2</sup> Underfloor Heating StickyMat

Area Heated	Product Code	Wattage	Amps	Price (Excl 20% VAT)
1m <sup>2</sup>	SPM1	150W	0.65A	£91.24
1.5m <sup>2</sup>	SPM1.5	225W	0.98A	£114.58
2m <sup>2</sup>	SPM2	300W	1.30A	£130.83
2.5m <sup>2</sup>	SPM2.5	375W	1.63A	£161.24
3m <sup>2</sup>	SPM3	450W	1.96A	£186.66
3.5m <sup>2</sup>	SPM3.5	525W	2.28A	£209.58
4m <sup>2</sup>	SPM4	600W	2.61A	£232.08
4.5m <sup>2</sup>	SPM4.5	675W	2.93A	£254.99
5m <sup>2</sup>	SPM5	750W	3.26A	£282.49
6m <sup>2</sup>	SPM6	900W	3.91A	£333.33
7m <sup>2</sup>	SPM7	1050W	4.57A	£383.33
8m <sup>2</sup>	SPM8	1200W	5.22A	£418.74
9m <sup>2</sup>	SPM9	1350W	5.87A	£454.58
10m <sup>2</sup>	SPM10	1500W	6.52A	£489.16
11m <sup>2</sup>	SPM11	1650W	7.17A	£519.16
12m <sup>2</sup>	SPM12	1800W	7.83A	£566.24
15m <sup>2</sup>	SPM15	2250W	9.78A	£711.66

\*Prices above **DO NOT** include a Warmup thermostat. (See pages 43 - 55 for details).

## Price Guide for 200W/m<sup>2</sup> Underfloor Heating StickyMat

Area Heated	Product Code	Wattage	Amps	Price (Excl 20% VAT)
0.5m <sup>2</sup>	2SPM0.5	100W	0.44A	£59.99
1m <sup>2</sup>	2SPM1	200W	0.87A	£100.83
1.5m <sup>2</sup>	2SPM1.5	300W	1.30A	£126.24
2m <sup>2</sup>	2SPM2	400W	1.74A	£140.83
2.5m <sup>2</sup>	2SPM2.5	500W	2.17A	£172.08
3m <sup>2</sup>	2SPM3	600W	2.61A	£202.08
3.5m <sup>2</sup>	2SPM3.5	700W	3.04A	£227.49
4m <sup>2</sup>	2SPM4	800W	3.48A	£252.49
4.5m <sup>2</sup>	2SPM4.5	900W	3.91A	£274.99
5m <sup>2</sup>	2SPM5	1000W	4.35A	£303.33
6m <sup>2</sup>	2SPM6	1200W	5.22A	£358.33
7m <sup>2</sup>	2SPM7	1400W	6.09A	£413.74
8m <sup>2</sup>	2SPM8	1600W	6.96A	£454.58
9m <sup>2</sup>	2SPM9	1800W	7.83A	£489.16
10m <sup>2</sup>	2SPM10	2000W	8.70A	£524.16
15m <sup>2</sup>	2SPM15	3000W	13.05A	£765.41

\*Prices above **DO NOT** include a Warmup thermostat. (See pages 43 - 55 for details).

# Installation Guide

## (Refer to installation manual for complete instructions)

Make a floor plan of your floor area by measuring your room and then subtract any fixtures (such as baths and cupboards). Ensure you have the correct size mat for your floor area.

### Laying the Matting System

Roll out the mesh, wire face up. At the end of the run, cut the mat (**not the wire**), turn the mat through 90° or 180° and continue laying the mat. When the area is covered, adjust the mats until the loops are of equal distance apart. Affix the mat to the floor using its self-adhesive mesh, or using the double sided tape on the mat. Lay the temperature probe from the thermostat at equal distance between two of the cable loops and attach to the floor surface.

### Connecting to the power supply

**NOTE:** All electrical connections must be performed by a certified electrician.

Install an RCD fused spur to power the thermostat and the matting system heating element network.

Take the unheated power supply cable from the end of the matting system, which should be positioned near the thermostat. Make sure all the connections have been made to the power supply.

Turn the heater(s) on to ensure they are heating up (no more than 10 minutes).

### Completing the job

Either lay a thin, self-levelling screed over the mat and leave it to dry before laying tiles or trowel a full bed of flexible tile adhesive directly over the mat and lay the floor tiles.

#### MAT: with pressure sensitive adhesive

- ✓ Fastest and most secure installation
- ✓ Use less self-levelling compound and tile adhesive
- ✓ Can be repositioned easily without losing adhesion

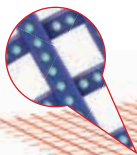

1. Heating Element Strand
2. Inner Insulation: advanced fluoropolymer
3. Earth Braid
4. Outer Insulation: advanced fluoropolymer
5. Glassfibre Mesh with pressure sensitive adhesive

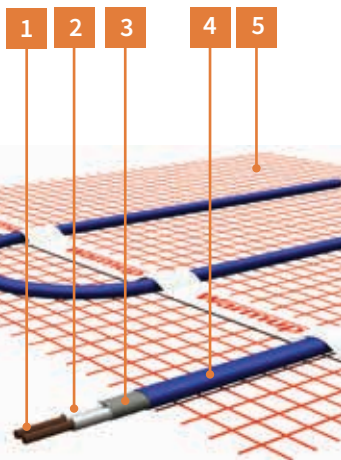

Features	Technical Data
Tough - 6mm thick heating cable is protected by multiple layers of metal shielding and insulation	<b>Operating voltage:</b> 230V: 50Hz
Floor covering can be changed without risk of damage to the heater	<b>Output rating:</b> 100 to 210W/m <sup>2</sup>
Heating element meets the highest safety standards	Single 2.5m long 'cold tail' connection lead
Grounding braid makes it safe for wet rooms	Approvals: VDE, European compliant and CE marked
Versatile - compatible with all floor finishes	10-Year Warranty & SafetyNet™ Installation Guarantee

Suitable for new-build

\*Prices above **DO NOT** include a Warmup thermostat. (See pages 43 - 55 for details).



Installation video for Warmup® StickyMat System.  
Always refer to the installation manual prior to commencing your project.





# Warmup® Inscreed Cable System

*Warmup® Inscreed Cable System is excellent for installation within screeded floors of any size. Once installed, the heated screed can be covered with any flooring.*

### Option 1:

#### Wire laid directly on insulation\*

For use where the concrete base is thicker than 100mm or uninsulated

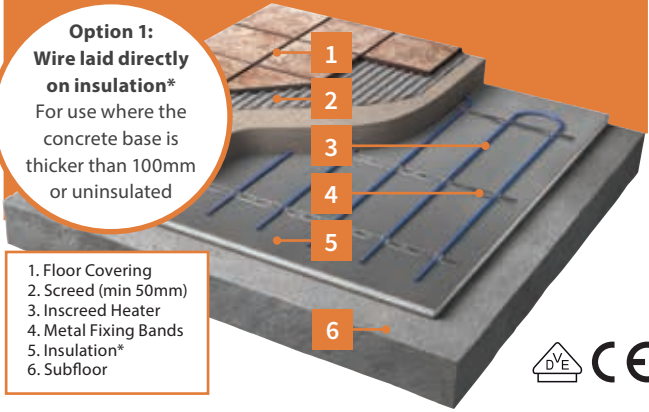

- 1. Floor Covering
- 2. Screed (min 50mm)
- 3. Inscreed Heater
- 4. Metal Fixing Bands
- 5. Insulation\*
- 6. Subfloor



### Option 2:

#### Wire laid directly on concrete slab

For use where the concrete base is less than 100mm thick or insulated

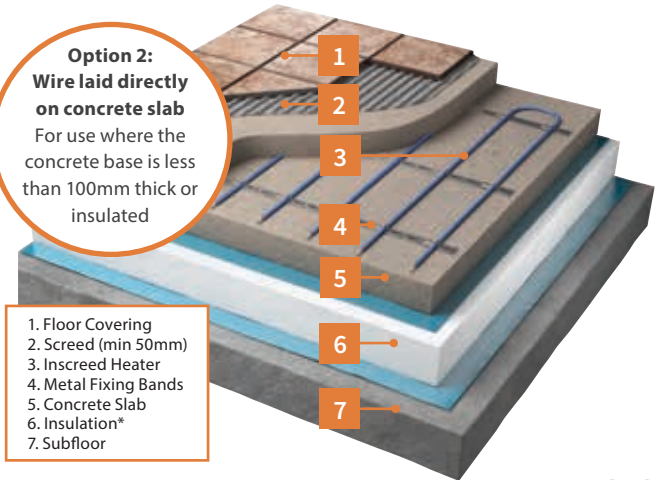

- 1. Floor Covering
- 2. Screed (min 50mm)
- 3. Inscreed Heater
- 4. Metal Fixing Bands
- 5. Concrete Slab
- 6. Insulation\*
- 7. Subfloor



\* Insulation must be either foil faced or concrete faced and suitable for use with electric underfloor heating



Features	Technical Data
Tough - 6mm thick heating cable is protected by multiple layers of metal shielding and insulation	<b>Operating voltage:</b> 230V: 50Hz
Floor covering can be changed without risk of damage to the heater	<b>Output rating:</b> 100 to 210W/m <sup>2</sup>
Heating element meets the highest safety standards	Single 2.5m long 'cold tail' connection lead
Grounding braid makes it safe for wet rooms	Approvals: VDE, European compliant and CE marked
Versatile - compatible with all floor finishes	10-Year Warranty & SafetyNet™ Installation Guarantee

Suitable for new-build

## Price Guide

Coverage at 100W/m <sup>2</sup>	Coverage at 150W/m <sup>2</sup>	Coverage at 210W/m <sup>2</sup>	Product Code	Heater Length	Wattage	Amps	Price (Excl. 20% VAT)
1.8m <sup>2</sup>	1.2m <sup>2</sup>	0.9m <sup>2</sup>	WIS180	9.0	180W	0.8A	£47.91
2.8m <sup>2</sup>	1.9m <sup>2</sup>	1.4m <sup>2</sup>	WIS280	14.0	280W	1.2A	£67.49
3.9m <sup>2</sup>	2.6m <sup>2</sup>	2.0m <sup>2</sup>	WIS390	19.5	390W	1.7A	£76.66
5.0m <sup>2</sup>	3.3m <sup>2</sup>	2.5m <sup>2</sup>	WIS500	25.0	500W	2.2A	£91.24
6.5m <sup>2</sup>	4.3m <sup>2</sup>	3.3m <sup>2</sup>	WIS650	32.5	650W	2.8A	£109.99
7.6m <sup>2</sup>	5.1m <sup>2</sup>	3.8m <sup>2</sup>	WIS760	38.0	760W	3.3A	£114.58
10.0m <sup>2</sup>	6.7m <sup>2</sup>	5.0m <sup>2</sup>	WIS1000	50.0	1000W	4.3A	£139.58
12.0m <sup>2</sup>	8.0m <sup>2</sup>	6.0m <sup>2</sup>	WIS1200	60.0	1200W	5.2A	£163.74
14.6m <sup>2</sup>	9.7m <sup>2</sup>	7.3m <sup>2</sup>	WIS1460	73.0	1460W	6.3A	£192.49
15.5m <sup>2</sup>	10.3m <sup>2</sup>	7.8m <sup>2</sup>	WIS1550	77.5	1550W	6.7A	£196.66
17.7m <sup>2</sup>	11.8m <sup>2</sup>	8.9m <sup>2</sup>	WIS1770	88.5	1770W	7.7A	£211.66
20.7m <sup>2</sup>	13.8m <sup>2</sup>	10.4m <sup>2</sup>	WIS2070	103.5	2070W	9.0A	£229.58
26.0m <sup>2</sup>	17.3m <sup>2</sup>	13.0m <sup>2</sup>	WIS2600	130.0	2600W	11.3A	£278.33
31.4m <sup>2</sup>	20.9m <sup>2</sup>	15.7m <sup>2</sup>	WIS3140	157.0	3140W	13.7A	£321.66
33.7m <sup>2</sup>	22.5m <sup>2</sup>	16.9m <sup>2</sup>	WIS3370	168.5	3370W	14.7A	£341.24

\*Prices above **DO NOT** include a Warmup thermostat. (See pages 43 - 55 for details).

Accessories	Price (Excl. 20% VAT)
Metal Fixing Bands - 25m	£42.91
Fixing Tape - 50m	£8.74

For more information about this product and installation videos scan the code.

Always refer to the installation manual prior to commencing your project.



# Installation Guide

(Refer to installation manual for complete instructions)

Draw up a floor plan to determine the placement of the thermostat, heating cable and the sensor probe.

## Laying the Inscreed Cable System

The metal fixing strips should be laid out perpendicular to the heating element runs. Secure these fixing strips on the insulation or concrete floor using fixing nails or adhesive.

The fixing strips should be evenly spread across the floor at intervals of 0.75 meters and placed so as to leave a 100mm border all the way around the room.

The heating cables should then be laid up and down the room and clipped into the fixing strip. Please check the sizing guide at the back of the installation manual to determine the cable spacing. To ensure an evenly heated floor, the cables should be spaced evenly at all times.

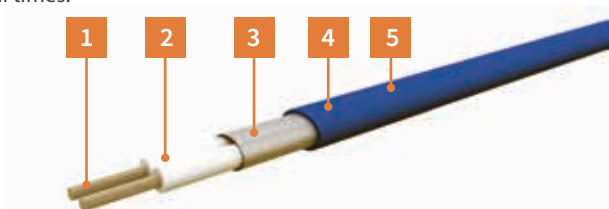

1. Heating Element Strand
2. Inner Insulation: advanced fluoropolymer
3. Earth Braid
4. Diameter 6mm
5. Outer Insulation: PVC

## Connecting to the power supply

The heating cable cold tail should be connected to the thermostat by a certified electrician. The heating cables should be tested again **BEFORE** screeding.

## Completing the job

Once laid, the heating cables must be covered with a minimum thickness of 50mm screed.

Install the Warmup thermostat and floor probe in one of the following ways:

1. Placed directly in the top 10mm of screed covering the heating wire
2. Placed into a channel cut out of the surface of the screed
3. Placed in a flexible conduit in the top 10mm of screed



**SAFETY Net™**  
Installation-Guarantee

## Frequently Asked Questions

### Can the Inscreed Cable System be shortened?

**Never shorten the Inscreed Cable.** You must ensure that the correct size is installed into the area. We have a large range of sizes to choose from.

### How thick is the screed used with the system?

The Warmup® Inscreed Cable is designed to be placed within a screed of at least 50mm in thickness. The exact floor build up depends on the insulation materials in the subfloor - please see the installation manual for full details.

### Can the Inscreed Cable System be laid directly onto insulation material? (i.e. single pour)

Yes, if you use cement-faced or foil-faced insulation boards suitable for electric underfloor heating such as the Warmup Insulation Boards.

### When can I turn my heating on?

The heating should not be activated until the screed has fully cured (approximately 7-28 days).

### Where should I place the floor probe?

The floor probe should be located at the surface of the screed layer below the floor covering (top 10mm of screed). It can also be cemented into a channel cut out of the surface of the screed.





# Warmup® Foil Heater System

The Warmup® Foil Heater is a streamlined electric radiant floor heater designed for use with carpet, vinyl, wood and other floating floors. We recommend using the Warmup Insulated Underlay and Dual Overlay Systems (See pages 38 - 39) for maximum efficiency.\* Warmup has successfully completed controlled tests with Amtico and Karndean flooring.

\*excludes bathrooms; cannot steam clean carpets

Contact Warmup to receive our technical guide for wood floors



- 1. Floor Covering
- 2. Warmup® Foil Heater
- 3. Insulated Underlay
- 4. Subfloor



Features	Technical Data
Installed directly under floor finish; no self-levelling required	<b>Construction:</b> Wire with advanced fluoropolymer insulation, encased in aluminium foil
Fully earthed flat aluminium foil will not raise floor levels	<b>Operating voltage:</b> 230V: 50Hz
Wire based system can be adapted to fit around objects	<b>Output rating:</b> 140W/m <sup>2</sup>
Great for heating under floating floors such as laminate and hardwood	<b>Mat width:</b> 0.5m
	<b>Mat length:</b> min 3m, max 24m
	<b>Heating cable spacing:</b> 50mm
	<b>Cold lead length:</b> 3m
	<b>Approvals:</b> BEAB
	European compliant and CE marked
	15-Year Warranty & SafetyNet™ Installation Guarantee



NOTE: MUST be used with the Warmup Insulated Underlay (See pages 36 - 37).  
NOTE: Must be used with Warmup Dual Overlay (See pages 38 - 39) when laying vinyl or carpet.  
NOTE: Always check compatibility of flooring with electric underfloor heating.

## Price Guide

Area Heated	Heaters	Wattage	Amps	Price (Excl. 20% VAT)
1	WLFH-140W/140	140W	0.61A	£67.49
1.5	WLFH-140W/210	210W	0.91A	£81.24
2	WLFH-140W/280	280W	1.22A	£102.08
3	WLFH-140W/420	420W	1.83A	£153.74
4	WLFH-140W/560	560W	2.43A	£192.49
5	WLFH-140W/700	700W	3.04A	£235.41
6	WLFH-140W/840	840W	3.65A	£278.33
7	WLFH-140W/980	980W	4.26A	£321.66
8	WLFH-140W/1120	1120W	4.87A	£365.41
9	WLFH-140W/1260	1260W	5.48A	£413.33
10	WLFH-140W/1400	1400W	6.09A	£456.66
12	WLFH-140W/1680	1680W	7.30A	£547.08

\* Prices above **DO NOT** include a Warmup thermostat. (See pages 43 - 55 for details).

MUST be used with the Warmup Insulated Underlay (See pages 36 - 37). If you are laying a vinyl or carpet (excludes bathrooms) the Warmup Dual Overlay MUST be used (See pages 38 - 39).

A maximum of 25m<sup>2</sup> of heating can be used with one thermostat.

For more information about this product and installation videos scan the code.

Always refer to the installation manual prior to commencing your project.



## Installation Guide

### (Refer to installation manual for complete instructions)

Warmup's foil heating mats are available in several convenient sizes. Use larger mats as much as possible and smaller mats as gap fillers. Ideally, the combination should cover 80% of your floor area. Exclude permanent or static fixtures from your calculations.

### Laying the Foil Heater System

Lay the heating mats on top of the insulation, leaving a gap of around 50mm from the wall to the heating mats and a gap of about 10mm between each mat. Stretch and secure the mats to the floor with the aluminium tape provided. Additional duct tape can be used where required.

Place the mat's electrical supply cables towards the junction box, ensuring they do not cross each other. Create a slight groove in the insulation under the joint to ensure that the heating mat lays flat.

## Connecting to the power supply

**NOTE:** All electrical connections must be performed by a certified electrician.

## Completing the job

Create a groove in the subfloor to accommodate the floor probe. Connect the floor temperature sensor to the thermostat through a conduit and install between two heating wire runs on the mat. The probe wire must **NEVER** touch or be crossed by the heating element.

## Frequently Asked Questions

### What types of flooring can be used?

The Foil Heaters can be used under carpet, vinyl, wood or floating floorings provided they are no thicker than 18mm and can withstand up to 27°C of heat. Check with the manufacturer to ensure it is suitable for use with electric underfloor heating.

### Can the Foil Heaters be cut and turned?

You can cut and turn the foil casing to suit the shape of the room, but **NEVER** cut the wire. Once the aluminium foil has been cut and the mat has been re-positioned, use the aluminium foil tape provided to cover any exposed wire and link the two pieces of the mat. Please see the installation manual for full details and diagrams.

### When can I turn my Foil System on?

Once the finished floor has been laid, wired up and tested, the system can be switched on immediately.

### Which insulation materials should be used?

We recommend Warmup's own brand Insulation Underlay to be used with Warmup® Foil Heaters. If you are installing a soft flooring such as vinyl or carpet, use the Warmup Dual Overlay to protect the foil heating wire from heels and heavy load points.

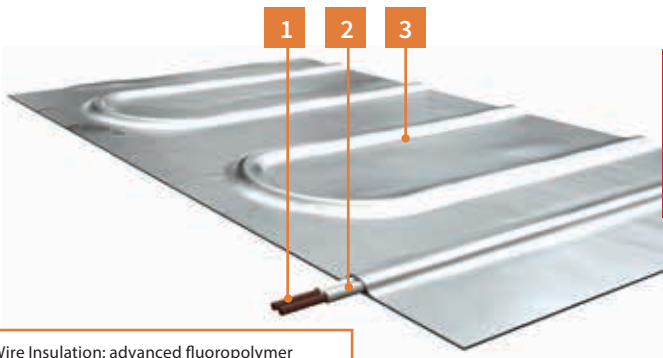

1. Wire Insulation: advanced fluoropolymer
2. Multi-strand twin conductors heating element
3. Aluminium Foil Earth

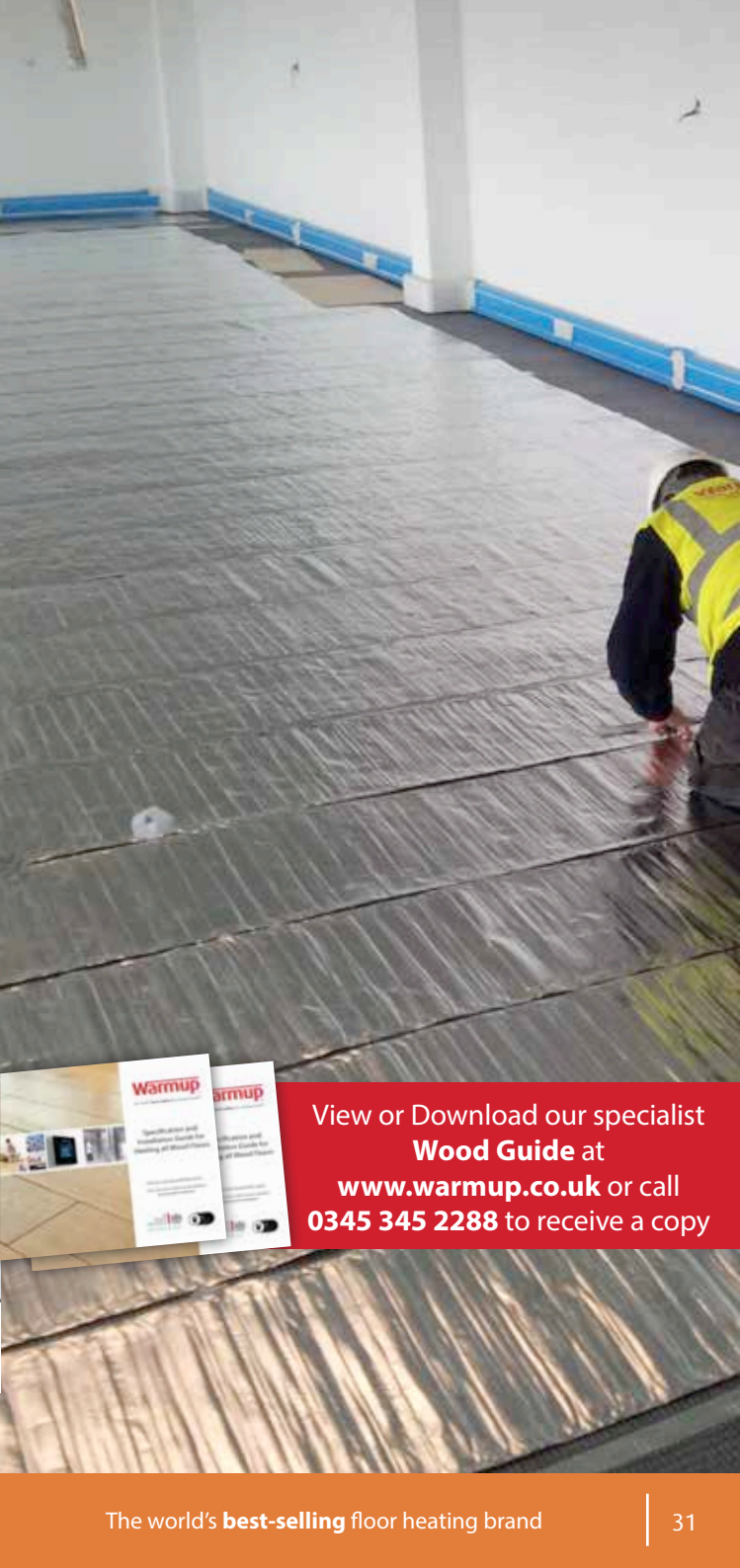

View or Download our specialist  
**Wood Guide** at  
[www.warmup.co.uk](http://www.warmup.co.uk) or call  
**0345 345 2288** to receive a copy



# Cement Coated Tough Insulation Boards

*Insulate and waterproof in one easy step with Warmup® Insulation Boards. Made from extruded polystyrene and faced with 0.5mm glassfibre mesh reinforced polymer-modified cement mortar, they have a high thermal insulation property for energy efficiency and an added benefit of sound proofing. The boards can be used on walls or floors and are ideal for applications such as dry lining, insulating and waterproofing in areas such as wetrooms, bathrooms and kitchens.*



Insulation boards prevent heat loss to the subfloor - a warm floor can be achieved in as little as 20 minutes compared to over 2 hours with no insulation (see the heat-up chart on page 34 for more details).

Features	Technical Data
Easy to cut and shape around fixtures with a knife or saw	<b>Board size:</b> 1,250mm (L) x 600mm (W)
Comes in a range of thicknesses to suit floor and wall applications. Can be fixed to solid or stud walls	<b>Thickness:</b> 6mm, 10mm, 20mm, 30mm, 40mm, 50mm
Holds wall tiles up to 62kg/m <sup>2</sup> and floor tiles up to 30 tonnes/m <sup>2</sup>	<b>Composition:</b> Extruded polystyrene, each side faced with a nominal 0.5mm thick glassfibre mesh reinforced polymer-modified cement mortar
Joints must be sealed to make them waterproof	<b>R Value:</b> (6mm) 0.16; (10mm) 0.28; (20mm) 0.58; (30mm) 0.88; (40mm) 1.20; (50mm) 1.50
High thermal insulation, resisting heat loss and increasing the heating system's efficiency	Class "0" / "B1" fire rated
Impact sound reduction $d_{lW}=21$	No primer required when used in conjunction with underfloor heating
Ready for tile/plaster - <b>no</b> additional prep work needed	European compliant and CE marked
Excellent as internal wall insulation especially when compared to standard cement building boards and plaster boards	Conforms to Building Regulations Part L



## Price Guide

Area Heated (m <sup>2</sup> )	No. of Boards req	Price (Excl. 20% VAT)					
		6mm	10mm*	20mm	30mm	40mm	50mm
1	2	£38.32	£38.32	£51.66	£64.16	£74.16	£92.48
2	3	£57.48	£57.48	£77.49	£96.24	£111.24	£138.72
3	5	£95.80	£95.80	£129.15	£160.40	£185.40	£231.20
4	6	£114.96	£114.96	£154.98	£192.48	£222.48	£277.44
5	7	£134.12	£134.12	£180.81	£224.56	£259.56	£323.68
6	9	£172.44	£172.44	£232.47	£288.72	£333.72	£416.16
7	10	£191.60	£191.60	£258.30	£320.80	£370.80	£462.40
8	11	£210.76	£210.76	£284.13	£352.88	£407.88	£508.64
9	13	£249.08	£249.08	£335.79	£417.04	£482.04	£601.12
10	14	£268.24	£268.24	£361.62	£449.12	£519.12	£647.36
11	15	£287.40	£287.40	£387.45	£481.20	£556.20	£693.60
12	17	£325.72	£325.72	£439.11	£545.36	£630.36	£786.08
13	18	£344.88	£344.88	£464.94	£577.44	£667.44	£832.32
14	20	£383.20	£383.20	£516.60	£641.60	£741.60	£924.80
15	21	£402.36	£402.36	£542.43	£673.68	£778.68	£971.04
16	22	£421.52	£421.52	£568.26	£705.76	£815.76	£1,017.28
17	24	£459.84	£459.84	£619.92	£769.92	£889.92	£1,109.76
18	25	£479.00	£479.00	£645.75	£802.00	£927.00	£1,156.00
19	26	£498.16	£498.16	£671.58	£834.08	£964.08	£1,202.24
20	28	£536.48	£536.48	£723.24	£898.24	£1,038.24	£1,294.72

Product Code	Description	Length (mm)	Width (mm)	Thickness (mm)	Board Price (Excl. 20% VAT)
INSBOARD6mm	6mm Cement Coated Insulation Board	1250	600	6	£19.16
INSBOARD10mm	10mm Cement Coated Insulation Board	1250	600	10	£19.16
INSBOARD20mm	20mm Cement Coated Insulation Board	1250	600	20	£25.83
INSBOARD30mm	30mm Cement Coated Insulation Board	1250	600	30	£32.08
INSBOARD40mm	40mm Cement Coated Insulation Board	1250	600	40	£37.08
INSBOARD50mm	50mm Cement Coated Insulation Board	1250	600	50	£46.24
INSBOARDPLAIN10mm	10mm Uncoated Insulation Board	1250	600	10	£10.83
INSBOARDPLAIN20mm	20mm Uncoated Insulation Board	1250	600	20	£11.66

\*Standard board thickness = 10mm

# Heat-Up Chart

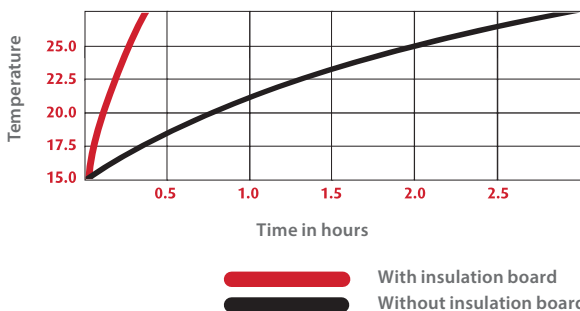

In testing, heat-up time was cut from over 2 and a half hours to just 20 minutes. This data applies to Warmup® heating products only.

\* Assumes a system running twice a day for 2 hours on a concrete subfloor

\*\* Source: Warmup tests performed to EN442-2 standards

## Installation Guide

(Refer to installation manual for complete instructions)

### Installation onto concrete floors

Lay the boards on a concrete base and stagger the joints. Fix the boards to the concrete base with a suitable flexible tile adhesive. Once the adhesive hardens, tape the joints with glassfibre tape.

**Installation onto wooden floors (Contact us on 0345 345 2288 to receive a copy of our technical guide for wood flooring or visit [www.warmup.co.uk](http://www.warmup.co.uk)).**

On a wooden subfloor, lay the boards and stagger the joints. Fix with a suitable flexible tile adhesive. When the adhesive has set but not necessarily dried, fix the boards with a screw fixing and washer at 200mm spacings. Ensure the screw head is flush with the surface. Reinforce the joints with glassfibre tape.

### Installation onto walls

Fix the lightweight boards to any suitable framework, such as wood or brick. Boards can easily be cut with a knife or sawed to work around objects. Use 8 galvanised screws per m<sup>2</sup> at a minimum of 30mm from edges. Tighten screws until washers bite the board surface, then level the washer with a rubber mallet. Cover joints with self adhesive glassfibre tape embedded in a layer of flexible tile adhesive.

Installation video for Warmup® Insulation Boards.

Always refer to the installation manual prior to commencing your project.



Item Code	Description	Price (Excl. 20% VAT)
Glassfibre Tape	25m roll	£4.16
WIBS40MM	Wooden Screws - 40mm (100 per pack)	£3.33
WIBW36MM	Penny Washers - 36mm diameter (50 per pack)	£5.83

## Frequently Asked Questions

### Where can I use it?

**Floors & Walls:** Warmup® Insulation Boards can be used as a structural tile backer board on the floor, withstanding a load of 30 tonnes/sqm and are ideal for use with underfloor heating. They offer the added benefit of high sound proofing properties. We recommend a minimum thickness of 6mm on a concrete subfloor and 10mm on a wooden subfloor for floor stability. As wall tile backer boards, tiles can be fixed directly onto the surface without prior preparation. When the joints are sealed it is totally waterproof, offering an ideal solution for use in bathrooms, shower rooms, wetrooms and kitchens.

### What is it made from?

Warmup® Insulation Boards are made of waterproof extruded polystyrene and have a glassfibre mesh embedded on each face, onto a cement polymer adhesive. The boards are fully waterproof, preventing any water to pass through them in the way expanded polystyrene boards do. They are lightweight, easy to cut with a knife and install onto any surface. Being free of harmful asbestos, they pose no health or safety risks and are unaffected by the freeze/thaw cycle.

### What is an R Value?

The R value is a measure of thermal resistance used in the construction industry. The higher the R value the better an insulator (e.g. 10mm Warmup® Insulation Boards have an R value of 0.28 m<sup>2</sup>K/W and the 20mm Warmup® Insulation Boards have an R value of 0.58 m<sup>2</sup>K/W). All buildings should strive for the highest possible R values to reduce the amount of energy used.

### Why do you recommend insulation boards on a concrete base?

Insulation boards can reduce running costs by as much as 50% because they are a highly efficient thermal barrier to cold rising from the subfloor. By reflecting the heat upwards into the floor instead of losing heat to the subfloor, the floor will be warm in approximately 20 minutes after the system comes on. Without insulation boards it could take several hours. This is important for energy efficiency for today's energy-conscious consumers. See the heat up chart example on page 34 for more details.



# Warmup® Insulated Underlay

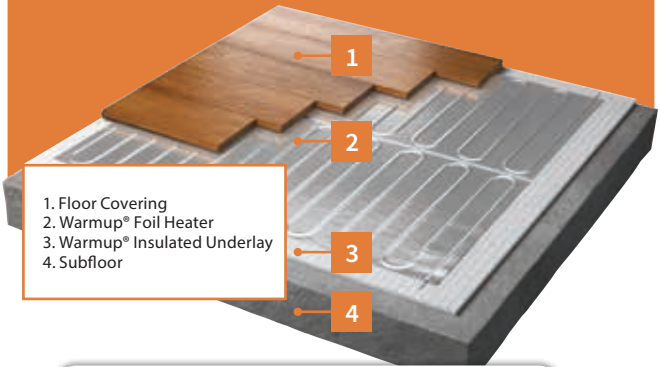

*Warmup® Insulated Underlay is a thin polystyrene insulation barrier with effective acoustic properties to reduce contact noise. It sits between the cold subfloor and Warmup's Foil Heater, reflecting heat upwards, making the heating system even more efficient. The foil backing acts as a moisture barrier.*



- 1. Floor Covering
- 2. Warmup® Foil Heater
- 3. Warmup® Insulated Underlay
- 4. Subfloor

Scan the code for more information about this product.

Always refer to the installation manual prior to commencing your project.

Features	Technical Data
Resists heat loss and increases the heating systems efficiency	<b>Roll Size:</b> 1200mm (W); 2.5sqm, 5sqm, 10sqm and 25sqm
Extremely effective for reducing contact noise	<b>Thickness:</b> 6mm
Very thin at only 6mm in depth	<b>Composition:</b> <b>Top Layer:</b> Grooved polystyrene <b>Bottom layer:</b> Silver foil with adhesive overlap
Lightweight and easy to install	<b>R Value:</b> 0.19 m <sup>2</sup> K/W
Foil backing acts as a moisture barrier	<b>Contact sound reduction:</b> 25dB ΔLw when used in conjunction with the Warmup Dual Overlay System.

Recommended for use with the Warmup®Dual Overlay System

## Price Guide

Area Covered	Insulated Underlay System Code	Price (Excl. 20% VAT)
2.5m <sup>2</sup>	WIU2.5	£27.91
5.0m <sup>2</sup>	WIU5.0	£52.49
10.0m <sup>2</sup>	WIU10.0	£102.98
25.0m <sup>2</sup>	WIU25.0	£240.41

In the case of floating substrate systems the sound reduction of the finished floor covering will always depend on the impact sound reduction of the existing substrate.

## Installation Guide

**(Refer to installation manual for complete instructions)**

Install the Insulation Underlay with the silver foil facing down onto a clean and dry floor. After fitting the first row, roll the next section of underlay. Remove the protective film from the self-adhesive overlap and stick both rows together, creating a damp proof barrier. Stagger subsequent rows until the whole floor area is covered.

## Frequently Asked Questions

### What is it made from?

The top layer of the underlay is comprised of a 6mm grooved lightweight polystyrene (which offers added acoustic properties by reducing contact noise) and a bottom layer of silver foil which has an adhesive overlap to join subsequent rolls. The underlay has a sound reduction of 25dB ΔLw when used in conjunction with Warmup® Dual Overlay (See pages 38 - 39). In the case of floating substrate systems, the sound reduction of the finished floor covering will always depend on the impact sound reduction of the existing substrate.

### What is an R Value?

The R value is a measure of thermal resistance used in the construction industry. A rating of 0.19 represents a low level of insulation for energy efficiency.

### Can I use this under tiles and stone?

No. It is designed for installation with the Foil Heater when installed under soft and resilient floor coverings such as wood, carpet, vinyl and linoleum. When your finish needs to be fixed down (glued) such as carpet, then a combination of the Insulated Underlay, Foil Heater and Dual Overlay should be used. Warmup's Insulated Underlay has been specially developed as part of a complete stable overlay system with the Dual Overlay to protect the heating wire from sharp heels and heavy point loads. The combined thickness of the Warmup® Dual Overlay and the Warmup Insulated Underlay is 13mm.



# Warmup® Dual Overlay

*Warmup® Dual Overlay is a free-floating subfloor, offering a smooth and seamless finish for carpet, vinyl and linoleum. The two layers protect the heating wire from sharp or heavy point loads and provide even heat distribution. Installation is dry, clean and quick. The Insulated Underlay and Dual Overlay are designed to work together with Warmup Foil Heaters (See pages 28 - 30).*

1. Floor Covering
2. Warmup® Dual Overlay-Top
3. Warmup® Dual Overlay-Base Board
4. Warmup® Foil Heater
5. Warmup® Insulated Underlay
6. Subfloor

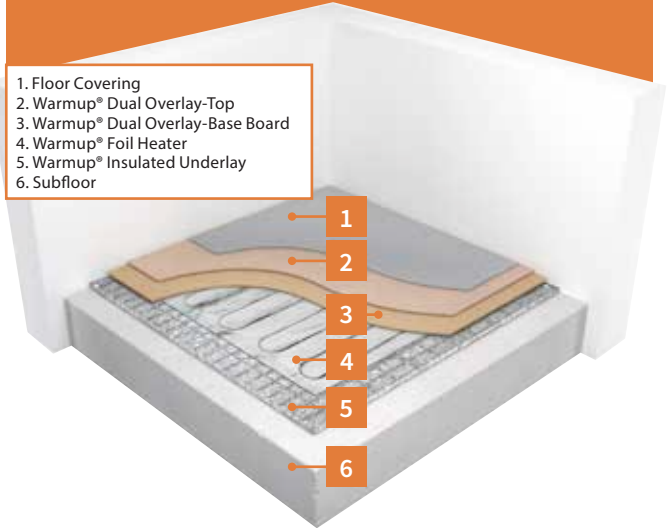

Features	Technical Data
Consists of a base board (3mm deep) and top board (4mm deep) with a contact adhesive to bond them together	<b>Contents:</b> 4 base and 4 top boards (covers 2.88m <sup>2</sup> )
Provides a stable subfloor on which a variety of floor coverings can be laid	<b>Size:</b> 1200mm (W) x 600mm (L)
Very thin at only 7mm in depth	<b>Thickness:</b> Base board - 3mm Top board - 4mm
Protects electric heating wire from damage if flooring is not laid immediately	<b>Composition:</b> MDF fitted with an interactive adhesive
Installation is quick, easy and dry - no need for self-levelling	<b>Density (kg/m<sup>3</sup>):</b> 770
Provides even heat distribution	<b>Bending strength kg/cm<sup>2</sup>:</b> >40
	<b>Humidity (%):</b> 4-10
	<b>Thermal R value (m<sup>2</sup>K/W):</b> 0.047
	<b>Fire Class, DIN4102:</b> B2

NOTE: Always check compatibility of flooring with electric underfloor heating.

## Price Guide

	Price (Excl. 20% VAT)
WDO - Dual Overlay System (covers 2.88m <sup>2</sup> )	£76.66/pk

Scan the code for more information about this product.

Always refer to the installation manual prior to commencing your project.



## Installation Guide

**(Refer to installation manual for complete instructions)**

The Warmup® Dual Overlay is comprised of a 3mm deep base board and 4mm deep top board. The bottom and top layers are laid out with staggered joints and arranged so that the top boards overlap the joints in the base boards. The Warmup® Foil Heating System lays between the Underlay and Dual Overlay System. This method of installation provides a stable surface for the floor finish to rest on and avoid any joints showing through the final floor finish. Finally, the floor finish can either be glued to the boards as a final layer or simply laid freely upon them.

## Frequently Asked Questions

**Is the Dual Overlay fixed to the subfloor?**

The Warmup® Dual Overlay is a floating subfloor - it is not fixed to the floor below. It is comprised of a 3mm deep base board and a 4mm deep top board. Both boards have contact adhesive, bonding them together to make one solid subfloor, to which a variety of floor coverings may be fixed. It provides a smooth and seamless subfloor making it suitable for soft and resilient floor coverings such as carpet, vinyl and linoleum. The combined thickness of the Underlay and Dual Overlay is 13mm.

**How is it sold?**

Each pack contains: 4 base boards & 4 top boards and covers 2.88m<sup>2</sup> of flooring.

**Can I use other Warmup Heaters with the Underlay/ Dual Overlay?**

The Warmup Underlay / Dual Overlay systems are designed to work specifically with Warmup Foil Heaters only.

**Please Note:**

\* Cannot be used in wet areas such as bathrooms.

\*\*It is strongly recommended to dry clean carpet flooring laid on Dual Overlay. Do not steam clean, as this can cause moisture to get into the wood and joints and show through the flooring over time.



# 150W & 200W/m<sup>2</sup> In-Wall Heating Panel

*In-Wall Heating Panels are perfect if you wish to extend the luxury of the floor heating to the walls, ideal if you wish to heat a small area of the wall or for whole room heating; this is particularly suitable in dwellings where heat loss and poor insulation is an issue.*

*The In-Wall Heater Panels, suitable for use behind tiles or natural stone are available in two wattages, 150W/m<sup>2</sup> & 200W/m<sup>2</sup>, offering you a choice to add additional heat with the 200W/m<sup>2</sup> which is particularly suitable for high heat loss rooms.*

**For more information on the application of the In-Wall Heater Panels or to receive a quotation please contact our Projects Division on 0345 034 8270 or visit our website [www.warmup.co.uk](http://www.warmup.co.uk)**



Features	Technical Data
The thinnest dual-fluoropolymer coated heating wire (less than 1.8mm diameter)	<b>Operating Voltage:</b> 230V: 50Hz
Toughest wire - multi-strand core, double-insulated using advanced fluoropolymers (ECTFE).	<b>Width:</b> 500mm (0.5 metre)
Sturdy glassfibre mesh for extra durability.	<b>IP Rating:</b> IPX7
High quality double-sided tape, for easier installation.	<b>Output Rating:</b> 150W/m <sup>2</sup> and 200W/m <sup>2</sup>
	<b>Protection Class:</b> I
	CE Marked
	Lifetime Warranty and SafetyNet™ Installation Guarantee



Scan the code for more information about this product.



Always refer to the installation manual prior to commencing your project.







# Warmup Smart.

## Our Philosophy

Warmup Smart is passionate about creating products that work simply and beautifully, whilst improving the efficiency and comfort of your home. We believe that your home is where you feel safe, relaxed and comfortable; the place you go to disconnect from all the distractions of day-to-day life. Our work is built on these foundations.

Our goal is to improve home-life.

With Warmup Smart, managing your heating system has never been so easy. Our smart products save you energy and money, on average £378 per year for a typical UK home. They eliminate the necessity to manage your system, without any effort on your behalf, giving you one less thing to worry about and allowing you to focus on the things that matter, like family, friends and stress-free time.



### SmartGeo™

Always at the right temperature automatically, and up to 25% lower energy usage. Just like magic



### Easy to use

Simple and secure set up using WiFi, with 24/7 technical support



### EasySwitch™

Always on the best tariff, automatically. Saving on average £210

## The Result

Perfect central heating control from Warmup 4iE with +Kit, saving on average £378 per year.



# 4iE<sup>®</sup> SMART WIFI THERMOSTAT

For central and underfloor heating

*TTA Award Winner 2016:  
Best Innovation*



**The right temperature. The best tariff.  
Effortlessly.**

## **High-quality design and engineering**

Premium design, personalised for you.

The 4iE<sup>®</sup> is designed to look great in both modern and traditionally styled homes, with glass effect front faces, and bevelled chrome edges to reflect wall colours.

A range of vinyl overlays are available in bold colours and textured metal and wood effects. You can even use a custom photo to complement your wallpaper.

The large colour touchscreen can be customised with different themes and uploadable photo backgrounds. There's even a 7-day local weather forecast, and traffic alerts built in.





### **Always at the right temperature, home or away**

The 4iE® does not require programming, using SmartGeo™ it works with your smartphone to ensure your home is always at the temperature you want just as you arrive, and using more efficient temperatures when you're away.

If you want to use a conventional program or just want to make a quick change, the MyHeating™ app is simple and easy to use.



### **The most efficient settings for your home**

The 4iE® learns how you use your heating and the unique way your home responds to changes in temperature to calculate more efficient settings.



### **Automatically on the best energy tariff, year after year**

Using EasySwitch™ the 4iE® can find you lower energy tariffs and automatically switch to the best deal. According to the Department of Energy & Climate Change, switching energy tariff can save on average £210 (Source: CMA, June 2016).

You can choose to let the 4iE® switch for you automatically when a better deal is available or see the results and easily switch yourself.

### **Natural Language Programming™**

Programming that speaks your language.

If you don't want to use SmartGeo™ or just want to make a quick adjustment, Natural Language Programming™ is simple to use. It uses familiar terms and phrases to understand the requirements for your heating program, for example 'What time do you wake up?'



\*Upgrade for just £29.99 inc. VAT at [www.warmup.co.uk](http://www.warmup.co.uk)

## Easy to install and set up



- Two piece design and wireless software updates to reduce call-backs
- Easy to setup WiFi
- Free installer training classes
- Self guiding screw terminals prevent driver skipping

The 4iE® uses a standard 35mm deep back box to house connections behind its stylish facia. It is installed just like a traditional thermostat and therefore easily replaces existing controls – including covering fixing holes from old thermostats without the need for additional plates.

### Technical Data

**Dimensions:** (H/W/D): 90 x 120 x 18mm (from wall)

**Sensors:** Air and floor/ambient

**Installation depth:** 35mm back box

**IP rating:** IP33

3-Year Warranty with option to **upgrade to Lifetime Warranty**

**Approvals:** BEAB

CE Marked and European compliant

**Sensor Type:** NTC 10K 3m Long (can be extended to 50m)

**Size of Display:** 3.5"

**Compatibility:** Ideal for Electric and Hydronic underfloor heating up to 16A. Combi and System boilers with switch live (230VAC) input

**Er-P Class:** IV

Code	Description	Price (Excl. 20% VAT)
4iE OB	Onyx Black Smart WiFi Thermostat	£179.16
4iE BP	Bright Porcelain Smart WiFi Thermostat	£179.16

# Frequently Asked Questions

## How do I connect the 4iE® to my internet?

The 4iE® connects to WiFi just like a smartphone or laptop. Simply find your WiFi network in the 4iE menu and enter your password using the onscreen keyboard.

Once connected you need to create your MyHeating account. Go to [my.warmup.com](http://my.warmup.com) and register. From there you can add the 4iE to your account using the unique code displayed on the 4iE.

## Which heating systems can the 4iE® control?

The 4iE® can control Warmup's electric and hydronic underfloor heating as well as central heating (combi and system boilers). Central heating and hydronic underfloor heating systems are controlled using a 'switch live' wire.

Warmup recommends that you check with your heating system manufacturer or installer to find out if your system can be controlled by a 'switch live' wire. The 4iE should always be installed by a certified professional.

## Data Protection

MyHeating™ uses the same web security as online banking and each communication between your 4iE and MyHeating is protected using the same encryption the intelligence services use for classified documents.

Warmup backs-up and stores all data safely encrypted to protect it, with firewalls and electronic surveillance in place.

To ensure your system is safe, Warmup recommends your WiFi network is password protected and you do not share your log-in details with anyone. Warmup will never ask you for your password.

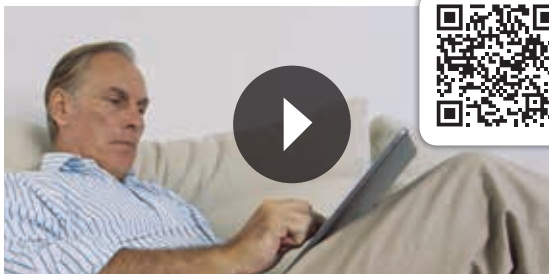

View the video for the Warmup 4iE® Smart WiFi Thermostat  
Always refer to the installation manual prior to commencing your project.

# Now you can use the innovative 4iE® with your Central Heating System

## NEW!

*The Warmup +Kit works with the 4iE (sold separately) to bring the energy and money saving features of the 4iE and free Warmup MyHeating App  to your entire central heating system.*

*The receiver unit, included in the kit, is simply connected to your boiler and communicates wirelessly with the 4iE which can be placed on the included stand anywhere in the home.*



Features	Technical Data	
	Boiler Receiver	Stand
Wireless control of boiler	<b>Dimensions:</b> 86 x 86 x 26.5mm	<b>Dimensions (Assembled with 4iE face):</b> 120 x 121.4 x 63.3mm
Works with most heating systems	<b>IP Rating:</b> IP40	<b>IP Rating:</b> IP30
Wall or stand mounted	<b>Electrical rating:</b> Max 230VAC @3A	<b>Guarantee:</b> 3 years
	<b>Guarantee:</b> 3 years	<b>RF Frequency:</b> 868MHz
	<b>RF Frequency:</b> 868MHz	



# Price Guide

Code	Description	Price (Excl. 20% VAT)
4iE Plus Kit	Warmup +Kit (for use with Warmup 4iE)	£70.83

## Compatibility

For use with the 4iE Smart WiFi Thermostat (sold separately). Compatible with hydronic underfloor heating systems up to 3A. Compatible with Combi and System boilers with 230VAC, volt-free or low voltage input up to 3A.

### Wireless control of boiler

The +Kit uses reliable wireless technology to control your boiler through walls and between multiple floors.

### Works with most heating systems

The +Kit works with 230V heating systems and volt-free or low voltage systems up to 3A. Simply wire the receiver unit using the wiring diagrams in the manual provided.

### Wall or stand mounted

The 4iE can be mounted on the included stand for easy placement, or mounted on the wall to replace an existing thermostat.

### What's in the box?

Boiler receiver, power base stand, power adapter with 1m USB cable, adhesive feet, operating and installation manual, mounting screws and reset pin.

### How it works

1. Boiler
2. Wireless Receiver Unit
3. 4iE® with +Kit

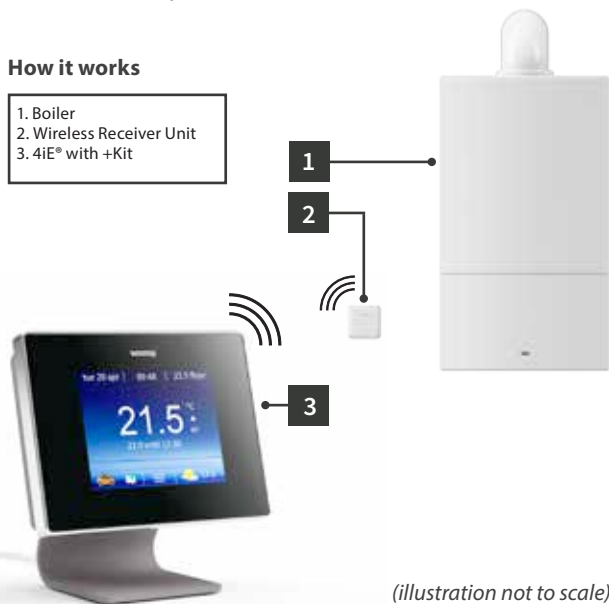

# Warmup 3iE<sup>®</sup> Energy-Monitor Thermostat

*Designed by Warmup<sup>®</sup>, the unique and exclusive 3iE<sup>®</sup> Energy-Monitor Thermostat was the first programmable thermostat to come with Active Energy Management™ prompting users to save up to 10% on energy bills.*



Features	Technical Data
Active Energy Management prompts users to save up to 10% on utility bills	<b>Output relay:</b> 16A, 3,600W
Easy-to-use interface eliminates complicated manuals	<b>Temperature range:</b> 0 / +50 °C
Unrivalled accurate floor temperature control of +/- 0.5°C, significantly reduces energy wastage	<b>Programming function:</b> 10 events and 10 temperatures / day
10 programmable periods per day for efficient energy use	<b>Sensors:</b> Floor/Air
Designed and available exclusively from Warmup	<b>Sensor Type:</b> NTC 10K 3m Long (can be extended to 50m)
Graphs show exact heating costs for underfloor heating	<b>Dimensions:</b> (H/W/D): 90mm x 113mm x 19mm (flush fit)
Stylish colours to suit any decor	<b>Size of display:</b> 2.4"
	<b>Installation depth:</b> 30mm
	<b>IP rating:</b> IP20/IP32 (with optional gasket)
	<b>Approvals:</b> BEAB
	European compliant and CE marked
	3-Year Warranty with option to <b>upgrade to Lifetime Warranty</b>
	<b>Er-P Class:</b> IV



\*Upgrade for just £24.99 inc. VAT at [www.warmup.co.uk](http://www.warmup.co.uk)

# Price Guide

Code	Description	Price (Excl. 20% VAT)
3iE PB	Piano Black Programmable Thermostat	£137.49
3iE CC	Classic Cream Programmable Thermostat	£137.49
3iE SG	Silver Grey Programmable Thermostat	£145.83
3iE LG	Leaf Green Programmable Thermostat	£145.83
3iE MB	Madison Blue Programmable Thermostat	£145.83
3iE DP	Deep Pink Programmable Thermostat	£145.83
3iE WB	Warm Berry Programmable Thermostat	£145.83

The world's first fully interactive, touch technology, energy-monitor thermostat features an easy-to-use interface, eliminating complicated instruction manuals. The display shows recorded energy consumption usage, so that users know the exact underfloor heating costs. Up to 10 programmable periods can be set each day to maximise energy efficiency.

## Innovative

First thermostat with a 2.4" full colour screen and integrated touch technology - patents pending.

Beautifully crafted fashion colour fascias with chrome edging are perfectly in tune with the modern home environment.

## Interactive

Clear graphical display makes any adjustment quick and easy.

Choose the display style that suits you best – wide choice of screen themes.

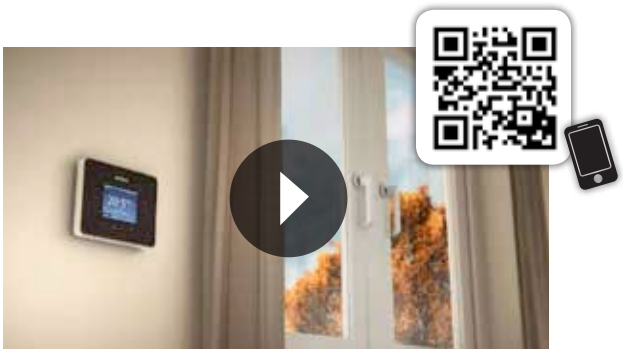

Installation video for Warmup 3iE energy-monitor thermostat. Always refer to the installation manual prior to commencing your project.

## Intelligent

Proportional Adaptive Function ensures the room does not over-heat, reducing wasted energy whilst also protecting the components inside. The Early Start algorithm learns how long it takes to warm the room and activates the heating so it's up to temperature at the right time.



## Energy Efficient

Unrivalled accurate floor temperature control means no wasted energy - reducing the costs associated with over-heating.

Graphical energy monitor shows exactly how much energy is being used and when.

Active Energy Management prompts you to choose the best and most efficient temperature for each room, maximising energy efficiency.

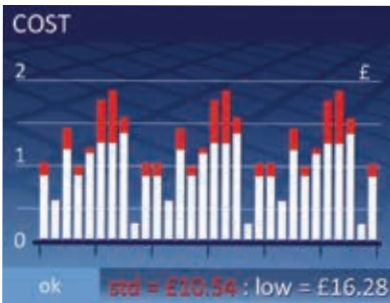

## Installation

The 3iE® Energy-Monitor Thermostat should be installed by a certified electrician only, using Warmup's installation instructions.

# Frequently Asked Questions

## What is Active Energy Management?

The 3iE® Energy-Monitor Thermostat has a unique feature called Active Energy Management. It displays graphs of the users recorded energy consumption. By following the on-screen prompts, users can save up to 10% on utility bills by choosing the best and most efficient temperature for each room.

## How many sensor settings does the 3iE have?

Warmup's 3iE® offers a choice of three sensor settings: air, external and floor.

This provides unrivalled accurate floor temperature control to maximise energy efficiency.

## Can more than one heater be controlled via the same thermostat?

Yes. Each thermostat can take up to 16 amps – **please note that the heaters should be wired in parallel only at the thermostat or junction box.** A maximum of two heaters can be wired directly into the back of the thermostat. If more than two heaters are used (combined load of less than 16 amps) they must be wired into a junction box, which connects to the thermostat.

For more than 16 amps a contactor and an RC unit are used in the circuit. Please consult a certified electrician or Warmup's Technical Team on: 0345 345 2288 for advice on this type of installation.



# Tempo Digital Thermostat

The Tempo thermostat enables end users to choose the time as easily as they would with a watch or clock and quickly set their programs – heat on when they want it and off when they don't need it.



Piano Black

Porcelain White



Features	Technical Data
Stylish and contemporary design	<b>Input voltage:</b> 230V +/- 15% at 50Hz
Clear screen displaying program details	<b>Max output:</b> 16A
Easy control with dial and sliders	<b>Dimensions:</b> (H/W/D): 90 x 113 x 23mm (flush fit)
Suitable with all Warmup electric and hydronic underfloor heating systems	<b>Screen size:</b> 45 x 50mm
Available in Porcelain White and Piano Black	<b>Sensors:</b> Floor/Air
Perfect for the whole house with the exception of the bathroom	<b>Sensor Type:</b> NTC 10K 3m Long (can be extended to 50m)
	<b>Programming:</b> 7-day, 1 day, 5/2 day
	<b>Battery backup:</b> 3 months (CR2032 battery provided)
	<b>IP rating:</b> IP20
	<b>Approvals:</b> BEAB
	European compliant and CE marked
	3-Year Warranty with option to <b>upgrade to Lifetime Warranty</b>
	<b>Er-P Class:</b> IV



\*Visit [www.warmup.co.uk](http://www.warmup.co.uk) for more details

## Also available



MSTAT Manual Thermostat

Suitable with Warmup's electric underfloor heating systems only



RCD/Fused Spur  
30mA  
Residual Current  
Device  
Fused Spur

# Price Guide

Programmable Thermostat	Price (Excl. 20% VAT)
Tempo - Piano Black Programmable Thermostat	£95.83
Tempo - Porcelain White Programmable Thermostat	£95.83

Manual Thermostats	Price (Excl. 20% VAT)
MSTAT - White Manual Thermostat	£67.49

Accessories	Price (Excl. 20% VAT)
RCD/Fused Spur - 30mA Residual Current Device	£46.24

## Tempo in each zone provides the following:

- ✓ **BETTER** easy-to-use interface and intuitive design
- ✓ **FASTER** set-up takes just minutes to get right the first time
- ✓ **SMARTER** control of energy costs

With Tempo, end users can simply program their settings to suit individual requirements, warmer when they are at home, lower when they are away or asleep.

It will help avoid wasting energy and achieve savings on utility bills.

Its Proportional Adaptive Function ensures the room does not over-heat, reducing wasted energy whilst also protecting the components inside. The Early Start algorithm learns how long it takes to warm the room and activates the heating so it's up to temperature at the right time.

## Frequently Asked Questions

### What is the difference between Tempo and the 3iE® Energy-Monitor Thermostat?

The main difference is the 3iE's energy-monitoring function. The monitor tracks your exact usage and based on your fuel rates, displays your underfloor heating costs. Through the Active Energy Management, it gives users suggestions to lower usage and fuel costs without sacrificing comfort.

### How does it work?

The sliding lever on the right-hand side takes you through the four easy program steps to set the day, time and heat periods you desire. Turn the dial to increase or decrease the settings and then press to secure that setting. The sliding lever at the bottom allows you to select between manual, automatic, frost-protection or off modes.



## Mirror Demisters

*Every bathroom needs a mirror - and all mirrors steam up. Warmup® Mirror demisters are the perfect solution; a thin film which sits between the back of the mirror and the wall - ensuring you never find yourself in the all too common predicament of wiping and smearing your mirror.*



Features	Technical Data
Flat film does not take up space	<b>IP57 Rated</b>
Self-adhesive for convenient installation directly onto the back of the mirror	<b>Suitable for zones 1 &amp; 2</b> according to BS7671
Resistant to moisture, vibration, shock, dust and ageing	<b>Operating voltage:</b> 230V: 50Hz
Connects to existing room light circuit for automatic operation when light is switched on	1m cold-tail
Suitable with most types of mirrors, existing or newly installed	Double insulated
Can be used in combination for large mirrors	No transformers or thermostats necessary
	European compliant and CE marked
	1-Year Warranty





## Price Guide

Size & Description	Wattage	Price (Excl. 20% VAT)
WMD1 - 400mm x 450mm	18W	£49.58
WMD2 - 600mm circular	55W	£67.91
WMD3 - 290mm x 290mm	27W	£36.66
WMD4 - 600mm x 1100mm	132W	£94.99

## Installation Guide

**(Refer to installation manual for complete instructions)**

The Mirror Demisters are self-adhesive and must be mounted directly onto the reverse side of the mirror or onto a smooth surface which is in direct contact with the mirror. **No other adhesives should be used.**

The Mirror Demisters should be connected by a certified electrician.

Scan the code for more information about this product.

Always refer to the installation manual prior to commencing your project.



## Frequently Asked Questions

**Do the Mirror Demisters come in different shapes?**

The Mirror Demisters come in round, square and rectangular shapes. Installation is as simple as exposing the self-adhesive backing and sticking it directly onto the back of the mirror.

**What if my mirror is bigger than my demister?**

The Demisters can be combined for larger mirrors. However, you must leave a minimum of 5mm between each Demister.

You must also leave a minimum of 10mm around the edges of the mirror to ensure the Demisters fit.

**How safe are they in the bathroom?**

The Mirror Demisters have an IP57 rating and are suitable for zones 1 and 2 according to BS7671, making them safe for bathrooms.

The Demister can either be connected directly to a switched light circuit, designed to activate the Demister when the light is switched on, or via a separate switch connected to the main lighting circuit.



## Electric Towel Rails

*When it comes to luxury, nothing beats the comfort of a soft, warm towel. Warmup® heated Towel Rails not only bring comfort, they also help to heat a bathroom.*

*Committed to innovation, whilst at the same time being energy efficient, Warmup's range of Towel Rails offer a solution to cater for all sizes of bathroom.*



HTR 680x450



HTR 800x600



HTR 800x600-curved



Features	Technical Data	Model		
		HTR 680x450	HTR 800x600	HTR 800x600C
Sleek contemporary design	Concealed Wiring Adaptor available	✓	✓	✓
Evenly distributed heat	Number of Bars	6	7	7
Discreet with concealed cable kit	Height mm	680	800	800
Versatile and easily installed into new or existing homes	Width mm	450	600	600
Fixing accessories kit, including a diamond drill bit (for tiles), for installation convenience	Depth mm	120	120	150
European compliant and CE marked	BTU output	188	341	341
5-Year Warranty	Wattage	55	100	100
	Amps @ 230Vac	0.23	0.43	0.43
	IP Rating	IP34	IP34	IP34



# Price Guide

Size & Description	Price (Excl. 20% VAT)
HTR 680 x 450	£196.66
HTR 800 x 600	£244.58
HTR 800 x 600 - Curved bars	£279.58
Concealed Wiring Adaptor	£10.41

Scan the code for more information about this product.

Always refer to the installation manual prior to commencing your project.



## Installation Guide

**(Refer to installation manual for complete instructions)**

The Towel Rails can be mounted by holding the Towel Rail in the desired position on the wall. Mark the position on the wall, remove the Towel Rail and drill holes into the tile/wall. Screw wall anchors into position, affix the Towel Rail onto the anchors and tighten with an allen key. Feed or recess power cables to point of connection.

**The Towel Rail must be wired by a certified electrician.**

## Frequently Asked Questions

**What materials are the Towel Rails made from?**

Warmup heated Towel Rails are made from the highest quality stainless steel.

**Do I need any special tools?**

The kit comes complete with fixing accessories, including a diamond drill attachment for tiles.

**What can I fix the Towel Rails to?**

The Towel Rail is designed to be fixed through wall cladding into solid wall framing, solid cement or masonry walls. Plasterboard toggles, at least 3mm diameter, may be used for two of the towel rail fixings.





## Outdoor Heating Solutions

*When it comes to safety in winter, every precaution should be taken. Using Warmup's outdoor heating solutions mean dangerous ice and snow build-up is reduced in concrete, paved or asphalt areas minimising the risk of accidents.*

### For Commercial and Residential use

Warmup® offers a range of solutions, whether commercial walkways, loading docks, ramps or residential driveways and stairs.

### Snow Melting Cables

The resistance-heating element has a single end connection and is completely grounded and safe. The 25W/m cable is ideal for outdoor areas in concrete, under pavers or asphalt.

The Snowmelt Cable is available in 2 different versions to suit concrete/slab and asphalt and comes with a 10 year warranty.

**For more information on the systems available or application of Snowmelt, please contact our Sales Support Team on 0345 345 2288 or visit [www.warmup.co.uk](http://www.warmup.co.uk)**

**Concrete Applications**



**Asphalt Applications**



Scan the code for more information about this product.

Always refer to the installation manual prior to commencing your project.



## Self-Regulating Cable

During the winter months when temperature drops and snow fall increases, roofs and gutters are affected.

Warmup's Self-Regulating Cable is perfect to protect pipes from freezing and gutters, roofs and downspouts from dangerous accumulation of ice and snow.

One of the unique differences between the Self-Regulating Cable and traditional heating cables is that the Self-Regulating Cable can be cut to the exact length required without damaging the heating properties of the cable.

Once the cable is in operation, it de-ices roofs and gutters from snow build-up by responding to the ambient temperatures – the heating output increasing, the colder the weather.

This ambient response function provides an energy efficient solution as it only increases its heating output when needed and achieves freeze protection by creating clear drain paths required for melted snow and ice to flow freely, avoiding the adverse results of winter.

**For more information on the application of the Self-Regulating Cable, please contact our Sales Support Team on 0345 345 2288 or visit [www.warmup.co.uk](http://www.warmup.co.uk)**



Scan the code for more information about this product.

Always refer to the installation manual prior to commencing your project.





## Patio Heaters

*Warmup® patio heaters are the perfect choice for outdoors in courtyards, conservatories and gardens.*



### Warmup® patio heaters emit radiant heat to warm an area up to 10m<sup>2</sup>

- ✓ Heaters can be fixed or you can purchase a tripod for greater flexibility to move the heater
- ✓ Heats-up in seconds, provides coverage of c.10m<sup>2</sup>
- ✓ Cost effective - 5 times CHEAPER to run than an equivalent gas heater
- ✓ Heaters are water-resistant
- ✓ Guaranteed for 5,000 hours of usage
- ✓ No need to refill

Scan the code for more information about this product.

Always refer to the installation manual prior to commencing your project.



Warmup Patio heater with tripod

## Price Guide

Code	Description	Price (Excl. 20% VAT)
WPH - 1760	Patio Heater	£166.66
WPH-TP	Patio Heater Tripod	£104.17
WPH - TPB	Tripod Bracket	£35.00





# Warmup® Hydronic Underfloor Heating Systems

*Warmup® offers you a complete bespoke solution Warmup® hydronic heating systems come designed and supplied with a full set of high quality components and controls ready for installation. Systems are available in a number of configurations and components guaranteed to perfectly match your project and budget.*

Warmup systems come with a choice of 3 pipe types; PEX-A, PE-RT and PE-RT/AL/PE-RT. This choice guarantees that you have the best possible system, tailored to your specific installation and budget.

Warmup® PEX-A hydronic pipe carries a **Lifetime Warranty for greater peace of mind.** All other pipes carry a 50 year Warranty.

Our unique SafetyNet™ Installation Guarantee means that should you accidentally damage the pipe on site, Warmup will exchange it free of charge.

**SAFETY Net™**  
Installation-Guarantee



Flooring Types	Screed and Concrete Floors	Timber Suspended and Batten Floors	Total-16
Page Number	62 - 71	72 - 79	80 - 81
Tile & Stone	✓	✓	✓
Hardwood	✓	✓	✓
Carpet	✓	✓	✓
Laminate	✓	✓	✓
Vinyl	✓	✓	✓







# Warmup® S3 Manifold

## NEW!

*The new market leading S3 Manifold by Warmup® is so named because it is built from one piece of seamless Stainless Steel. The new design features significant quality and efficiency developments, raising the benchmark for manifolds in the underfloor heating market.*

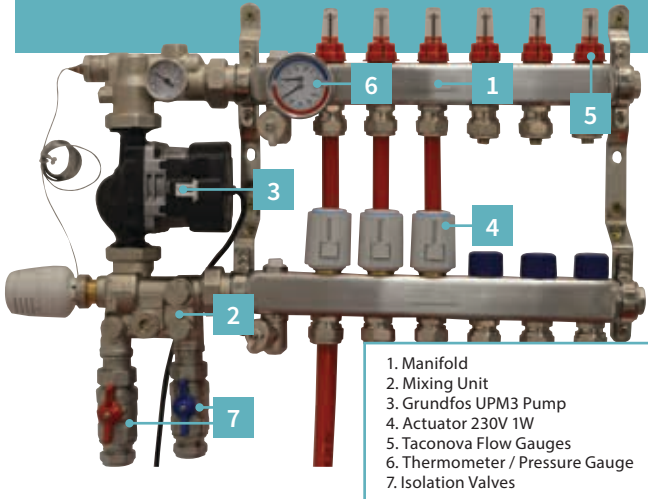

Features	Manifold Technical Data
High quality single piece stainless steel construction	<b>Material:</b> 304 Grade Stainless Steel
Dual temperature/pressure gauge drastically decreases setup time	<b>Ports Available:</b> 2 - 12
Accurate, reliable and easy to use flow gauges from Taconova	<b>Mixing Temperature:</b> 20°C to 60°C
3/4" Fill/drain valves fit standard tap connectors for easy commissioning	<b>Max Operating Pressure:</b> 6 Bar
The most energy-efficient actuators on the market	<b>Max Test Pressure:</b> 10 Bar
True 3 way mixing unit, with adjustable primary and secondary bypasses	<b>Flow Gauge Scale:</b> 0 - 5 l/min
Mixing unit compatible with traditional boilers, heat pumps and much more	<b>Measuring Accuracy:</b> ±10%
Latest Grundfos UPM3 'whisper quiet' circulator exceeds Ecodesign requirements	<b>Port Centres:</b> 50mm
Mixing control from 20°C to 60°C allowing screeds to be commissioned correctly and easily	<b>Standard Pipe Fittings:</b> 12x2mm and 16x2mm



## Warmup S3 System

### Excellent engineering - where it is most needed

The heart of the Warmup hydronic floor heating system is now comprised of all top of the range components; the seamless stainless steel S3 manifold, Tacconova flow gauges, thermometer/pressure gauge, energy efficient S3 actuator and the S3 mixing unit complete with the whisper quiet Grundfos UPM3 Pump.

## Warmup S3 Tacconova Flow Gauges

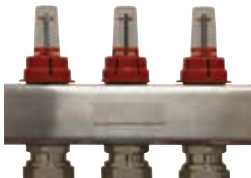

These strong and robust gauges are some of the most reliable flow meters on the market. They reduce pressure losses and increase performance.

## Warmup S3 Thermometer / Pressure Gauge



Pressure testing is made easier as the gauge is mounted directly on the manifold, saving installation time when multiple manifolds are being used.

## Warmup S3 Manifolds

Code	Description	Price (Excl. 20% VAT)
WHS-M-S3-02	2 port manifold	£128.93
WHS-M-S3-03	3 port manifold	£150.89
WHS-M-S3-04	4 port manifold	£171.14
WHS-M-S3-05	5 port manifold	£192.18
WHS-M-S3-06	6 port manifold	£215.18
WHS-M-S3-07	7 port manifold	£236.11
WHS-M-S3-08	8 port manifold	£257.14
WHS-M-S3-09	9 port manifold	£285.25
WHS-M-S3-10	10 port manifold	£301.32
WHS-M-S3-11	11 port manifold	£319.79
WHS-M-S3-12	12 port manifold	£343.57

## Warmup S3 Actuator 230V 1W

Information	Actuator Technical Data
 <p>The new Warmup S3 actuator uses less than half the energy of a typical actuator currently in use in the UK.</p>	<b>Operating Voltage:</b> 220-240V AC 50/60Hz
	<b>Operating Temperature:</b> 0 to 60°C
	<b>Power:</b> 1W
	<b>De-energized Position:</b> Normally Closed
	<b>Inrush Current:</b> max. 550 mA
	<b>Stroke:</b> 4mm
	<b>IP Rating:</b> IP54
<b>Storage Temperature:</b> -25 to 60°C	

## Warmup S3 Mixing Unit

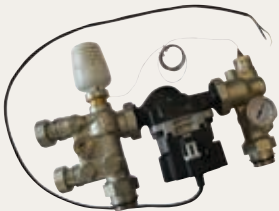
Information	Grundfos UPM3 Technical Data
 <p>This top of the range 'whisper quiet' mixing unit is set at a constant pressure curve, so circuits are balanced automatically as zones open and close. Having a built-in pump isolating valve means that there is no need to drain the entire system in the event of pump replacement.</p>	<b>Operating Voltage:</b> 230V AC 50Hz
	<b>Connections:</b> G1 1/2
	<b>Weight:</b> 1.9 (kg)
	<b>System Pressure:</b> Max. 1.0 MPa (10Bar)
	<b>Minimum Inlet Pressure:</b> 0.05MPa (0.50bar) at 95°C liquid temperature
	<b>Liquid Temperature:</b> +2°C to +110°C (TF110)
	<b>Enclosure Class:</b> IP44 (non-condensing) K: IPx4D (condensing)
<b>Motor Protection:</b> No external protection needed	
<b>Approval and Marking:</b> VDE, CE	

## Warmup S3 Manifold Ancillaries

Code	Description	Price (Excl. 20% VAT)
WHS-P-CONNECT	16mm x 2mm Pipe Connector	£2.50
WHS-P-CONNECT12	12mm x 2mm Pipe Connector	£2.50
WHS-M-S3-ACT230	230V Actuator	£25.21
WHS-M-S3-VALVES	Manifold valve kit - 1" isolating valve pair, 1" unions and 22mm compression fittings	£36.00
WHS-M-S3-MIX	Mixing Unit	£428.57



## Warmup® HydroPack Installation Kit



HydroPack is an easy-to-specify kit that comes with everything you need to install hydronic underfloor heating. It is the ideal solution for small projects of 22m<sup>2</sup> or less (additional products available for larger rooms), providing a maximum heat output of up to 3kW. The kit includes the Warmup® 3iE thermostat, the PE-RT pipe plus all the components necessary to complete a successful underfloor heating installation in a few hours.

HydroPack allows you to quickly purchase and install a hydronic system without the need to purchase each component separately. All the components are compatible and from a single source, packaged in one convenient kit for fast and easy installation.

You will need to ensure that the heat source has the sufficient capacity to supply sufficient energy for the HydroPack and other system requirements.

### Features

Compact and lightweight modular installation kit, designed to be connected onto existing pipework

Everything you need in one handy kit for quick and easy installation

All components are compatible and from a single source for reliability

Ideal solution for small projects of 22m<sup>2</sup> or less, providing a maximum heat output up to 3kW

Carries a comprehensive warranty of fifty (50) years on the pipe. You also get Warmup's unique SafetyNet™ Installation Guarantee – this means should you accidentally damage the pipe on-site, Warmup will replace it free of charge



**SAFETY Net**™  
Installation-Guarantee

# HydroPack Kit Contents

The HydroPack Installation Kit is made up of	
	16mm x 120m PE-RT pipe
	Single room 'A' rate energy efficient circulating pump/mixer control unit
	Compression fittings x2
	3iE™ Energy-Monitor Thermostat
	Pipe clips x600
	Pipe cutter
	Installation Instructions

## Pump/mixing unit

Technical Specification	
Compact bolt-on unit provides quick and easy installation	
Easy to set-up with an adjustable temperature range of 35 °C to 65 °C	
Delivers controlled mixed temperature water to the underfloor heating system with heat output of up to 3kW	
Controls flow temperature to +/-2 °C with changing boiler flow and return temperature	
<b>Maximum Static Pressure:</b>	10 bar
<b>Maximum Temperature:</b>	90 °C
<b>Adjustable Control Range:</b>	35 to 65 °C
<b>Factory Pre-set:</b>	35 °C (Minimum setting)
<b>Fail Safe Feature</b>	



# Installation Guide

## (Refer to installation manual for complete instructions)

Before commencing installation, ensure the insulation is laid on a clean and level subfloor. A perimeter strip or edge insulation will need to be laid around the perimeter of the room. The insulation should conform to building regulations or practices and laid as per manufacturers instructions.

The compact control and pump unit should be wall mounted in a vertical position on a suitable wall. Choose a suitable & solid mounting location, ensuring adequate clearance for primary and underfloor heating pipework and accessibility of the control unit.

Begin to unwrap and uncoil the pipe from the inside centre of the coil, cut the end off with the cutters to leave a neat square cut, but leaving a rounded pipe (i.e. not compressed). Once the pipe has gone through the compression fitting, insert the pipe into the flow from the mixer pump assembly for the underfloor heating. Refer to installation instructions.

Once connected, begin laying the pipework around the room using the preferred pipe pattern (see examples below). Take care to turn the coil of pipe as you uncoil it to relieve tension and staple the pipe using the pipe clips provided into the insulation. An allowance of 5 clips per linear metre of pipe has been included. However less clips may be required on the straight runs and more required on the loops.



### **Spiral pipe layout**

(for rectangular shaped rooms where even spread of heat is required)



### **Serpentine pipe layout**

(for odd shaped or specific-heat areas, i.e. to concentrate flow near windows or doors)



Once the pipework has been laid, work out where to cut the pipe for the final connections to the pump/mixer kit. Insert into the final compression fitting and connect to the pump/mixer valve. Tighten the compression fittings.

First the pipework will need to be filled and flushed with fresh cold water from the mains supply. Connect your hose to the flow side of the mixing valve that will be connected to the main flow from the heating system. Connect a hose to the return side of the mixing valve, that will flow back to the heat source for reheating. Place the mains water supply and flush through with the mains water until no air bubbles can be seen in the discharge of water.

Using a pressure testing kit (available for hire from your local plant/test hire or purchase from your local plumbers merchant), connect to the red valve and open. Build the pressure up to 6 Bar and hold for 1 hour. Once the test is complete then the system needs to be left under pressure during the screeding process. At least 2 Bar pressure is recommended for the process. This way if the pipework is damaged a leak and drop in pressure will be shown, then remedial repair work can take place as required.

Once the system has been installed and pressure tested it should be protected by laying the floor screed as soon as possible.

### Completing the job

If using a standard sand/cement screed, a thickness of between 65mm & 75mm on top of the insulation is recommended. The screed & screeding works must comply with current Building Regulations and attention must be paid to the curing times. Under no circumstances should the underfloor heating system be used to force curing of the screed. The mixing valve on the control pack should be set to the minimum temperature when commissioning commences after the screed has cured as per manufacturers instructions. Run with the heat on continuously for 3 days, after this a steady increase of 2 - 3°C per day can be adopted up to the desired working temperature. Then run for a further 4 days at this temperature. Ensure relative humidity of the screed is correct before laying floor finishes.

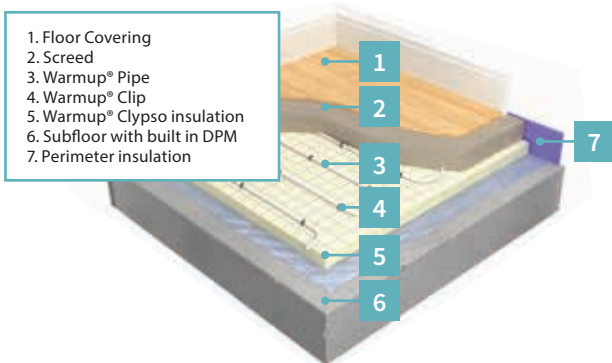



# Warmup® Clypso System

## *Screed and Concrete Floors*

The Clypso System uses plastic clips to secure the underfloor heating pipe to laminated insulation panels. The panels are constructed from either PIR (polyisocyanurate) or expanded polystyrene insulation with a fabric reinforced foil laminated to their surface. The foil on each panel comes with two flaps, for taping to the adjoining panel, thereby increasing water resistance and separating the insulation layer from the wet screed.

The laminated foil is printed with a grid pattern to make consistent pipe-spacing easier for the installer, especially when required to work around obstacles or a spiral installation pattern.

Insulation must comply with Building Regulations in force at the time of approval and BS/EN1264.

The Clypso System is suitable for almost any floor finish and in particular where the flooring (wood, carpet or vinyl) may be replaced from time to time.

### Insulation Features

The insulation is lined in 50mm grids to assist the installer in quickly placing the pipes in the correct design format and helps speed-up the installation process.

The Insulation fabric reinforced foil layer is woven to deliver extra security for retention of the pipe. This also makes it easier to install and provides additional protection against damage to the pipe prior to screed being laid.

Various compressive strengths are available, which safely allows the floor build-up to take imposed loads without damaging the integrity of the floor.



When PEX-A Pipe is used



Other pipes carry 50 year warranty

# Installation Guide

## (Refer to installation manual for complete instructions)

Make a layout plan of your floor area by measuring your room and then subtract any fixtures (such as baths and cupboards).

Ensure the installation area is dry and sealed to the elements and that you have a level floor surface. If installation is to take place onto a concrete base, install Warmup's polyethylene damp proof membrane and assess whether supplementary insulation is required before installing a perimeter insulation to prevent heat loss. This allows for some subfloor expansion due to temperature changes.

Although insulation is an integral part of the Clypso System, it may not fully comply with Building Regulations for new-build projects; additional insulation may be required depending on the existing subfloor construction.

The Clypso Insulation panels are then installed, covering the entire floor area providing an insulated surface for pipe installation. Once the Insulation panels are in place and the overlapping foil is taped down, the Warmup pipe circuits can be installed using a purpose-built clip gun and Warmup clips. The pipe is then fixed into place on the Clypso Insulation panels according to a predesigned pattern.

Before pouring the screed, attach the pipe to the manifold and pressure test it to ensure the system is working correctly. The system should be left under pressure until the flooring process is complete.

## Completing the job

Once the system has been tested, the screed should be laid over the system as soon as possible to prevent damage to the pipe and to allow the drying process to begin. The screed must be allowed to dry naturally until full strength is reached before turning on the underfloor heating, unless the screed manufacturer's instructions say otherwise.

The heating system is then turned on, gradually increasing the temperature of the floor over a number of days until the desired temperature is reached. Turning on the system too early or too high will dry the screed too quickly, damaging the screed. Underfloor heating and screed commissioning must take place as per manufacturer's instructions and British Standards.

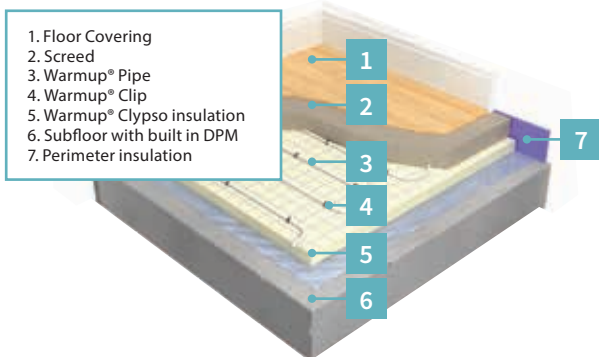



# Warmup® Metro Rail System

## *Screed and Concrete Floors*

The Metro Rail System uses pre-moulded retention clips. The rail is located on top of the insulation layer and is separated by a plastic membrane. The Metro Rail System allows pipes to be spaced as close as 50mm. The system holds the pipework in place until the screed is applied.

It is suitable for almost any floor finish and in particular where the flooring (wood, carpet or vinyl) may be replaced from time to time.

### Features

Designed to allow quick and easy installation - the rail provides guidance on how to install the pipework quickly and at the correct design spacing levels.

Holds the pipe at the correct level prior to screeding to ensure there are no hot spots.



When PEX-A Pipe is used



Other pipes carry 50 year warranty

## Installation Guide

**(Refer to installation manual for complete instructions)**

Make a layout plan of your floor area by measuring your room and then subtract any fixtures (such as baths and cupboards).

Ensure the installation area is dry and sealed to the elements and that you have a level floor surface. If installation is to take place onto a concrete base, install Warmup's polyethylene damp proof membrane and assess whether supplementary insulation is

required before installing a perimeter insulation to prevent heat loss. This allows for some subfloor expansion due to temperature changes. Although insulation is an integral part of the Metro Rail System, it may not fully comply with Building Regulations for new-build projects; additional insulation may be required depending on the existing subfloor construction.

The Insulation panels are then laid and fixed to the subfloor throughout the room and covered with a plastic membrane before installing the Metro Rail system on top. The Metro Rails are held in place using either an adhesive backing or by integrated fixing pins depending on the insulation system used.

When the Metro Rail system is firmly fixed in place, the pipe is then laid according to a predesigned pattern.

Once installed, attach the pipe to the manifold and pressure test to ensure the system is working correctly. The system should be left under pressure until the flooring process is complete.

### Completing the job

Once the system has been tested, the screed should be laid over the system as soon as possible to prevent damage to the pipe and to allow the drying process to begin. The screed must be allowed to dry naturally until full strength is reached before turning on the underfloor heating, unless the screed manufacturer's instructions say otherwise.

The heating system is then turned on, gradually increasing the temperature of the floor over a number of days until the desired temperature is reached. Turning on the system too early or too high will dry the screed out too quickly, damaging it. Underfloor heating and screed commissioning must take place as per manufacturer's instructions and British Standards.

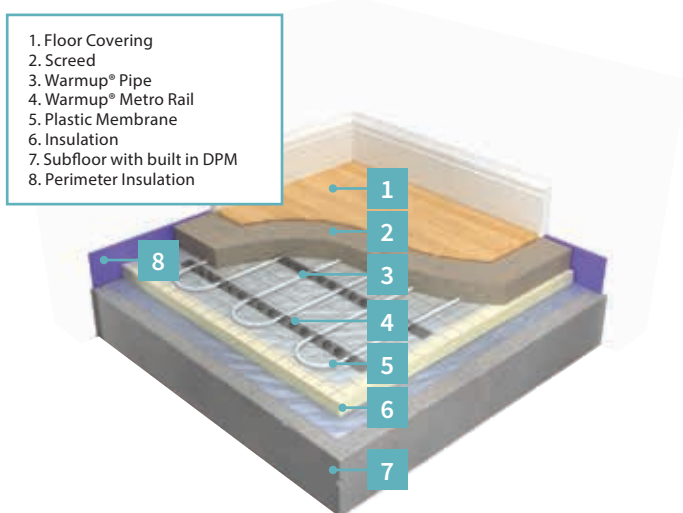



# Warmup® Tella Grid System

## *Screed and Concrete Floors*

The Tella Grid System uses a wire grid to which the underfloor heating pipework is attached using Warmup® plastic cable ties.

The wire grid is typically used to add structural support to the subfloor where extra strength is required due to high floor loadings.

The Tella Grid System is suitable for almost any floor finish and in particular where the flooring (wood, carpet or vinyl) may be replaced from time to time.

### Features

Wire grid provides best solution when a structural screed is required, particularly for high loads

The Tella Grid protects the integrity of the insulation from damage until the structural screed is laid

**SAFETY Net™**  
Installation-Guarantee



When PEX-A  
Pipe is used



Other pipes carry  
50 year warranty

## Installation Guide

**(Refer to installation manual for complete instructions)**

Make a layout plan of your floor area by measuring your room and then subtract any fixtures (such as baths and cupboards).

Ensure the installation area is dry and sealed to the elements and that you have a level floor surface. If installation is to take place onto a concrete base, install Warmup's polyethylene damp proof membrane and assess whether supplementary insulation is required before installing a perimeter insulation to prevent heat

loss. This allows for some subfloor expansion due to temperature changes. Warmup insulation panels are an integral part of the Tella Grid System. New-build projects may require additional insulation to comply with building regulations depending on the existing subfloor construction.

The Insulation boards are then laid and fixed to the subfloor throughout the room and covered with a plastic membrane before installing the Tella Grid.

Warmup's heating pipe is then laid out according to a predesigned pattern until your desired heated area is covered. The pipe should then be secured to the Tella Grid with plastic cable ties.

Attach the pipe to the flow connection on the manifold and conduct a pressure test to ensure the system is working correctly. The system should be left under pressure until screeded.

### Completing the job

Once the system has been tested, the screed should be laid over the system as soon as possible to prevent damage to the pipe and to allow the drying process to begin. The screed must be allowed to dry naturally until full strength is reached before turning on the underfloor heating, unless the screed manufacturer's instructions say otherwise.

The heating system is then turned on, gradually increasing the temperature of the floor over a number of days until the desired temperature is reached. Turning on the system too early or too high will dry the screed too quickly, damaging the screed. Underfloor heating and screed commissioning must take place as per manufacturer's instructions and British Standards.

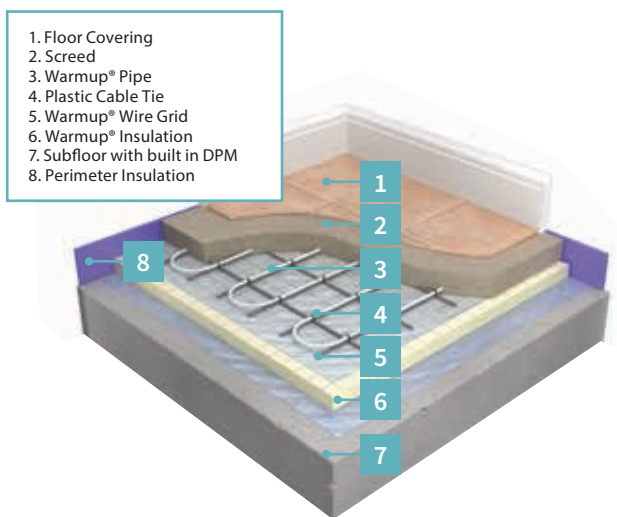



# Warmup® Nexxa Panel System

*Screed and Concrete Floors*

The Nexxa Panel System is used primarily where there are floor build-up issues to deal with. It can substantially reduce the overall build-up of the floor structure.

Warmup® system plates are interlocking vacuum formed sheets of plastic, incorporating pipe-locating castles.

Additional insulation may be required to meet the Building Regulations. The edges are over-lapped by 75mm, inter-locking them to form a continuous layer.

The Nexxa Panel System is suitable for almost any floor finish and in particular where the flooring (wood, carpet or vinyl) may be replaced from time to time.

## Features

The Nexxa panel has a low build up of just 30mm including the 20mm castellation. This makes it ideal for refurbishments or new build where a low build up floor is required.

Retains pipework prior to screeding.

Self-retaining system, no clips required.

**SAFETY Net™**  
Installation-Guarantee



When PEX-A Pipe is used



Other pipes carry 50 year warranty

## Installation Guide

**(Refer to installation manual for complete instructions)**

Make a layout plan of your floor area by measuring your room and then subtract any fixtures (such as baths and cupboards).



Ensure the installation area is dry and sealed to the elements and that you have a level floor surface. If the installation is to take place on a concrete base, install Warmup's polyethylene damp proof membrane and assess whether supplementary insulation is required before installing a perimeter insulation to prevent heat loss. This allows for some subfloor expansion due to temperature changes. Although insulation is an integral part of the Nexxa Panel System, it may not fully comply with Building Regulations for new-build projects; additional insulation may be required, depending on the existing subfloor construction.

The Nexxa Panels should be laid to have the edges overlapping by 75mm and interlocking with each new panel, creating a continuous layer.

Warmup's heating pipe is then laid out according to a predesigned pattern, ensuring that the pipe is firmly clipped down in each panel.

Once installed, attach the pipe to the manifold and conduct a pressure test to ensure the system is working correctly. The system should be left under pressure until the flooring process is complete.

### Completing the job

Once the system has been tested, the screed should be laid over the system as soon as possible to prevent damage to the pipe and to allow the drying process to begin. The screed must be allowed to dry naturally until full strength is reached before turning on the underfloor heating, unless the screed manufacturer's instructions say otherwise.

The heating system is then turned on, gradually increasing the temperature of the floor over a number of days until the desired temperature is reached. Turning on the system too early or too high will dry the screed too quickly, damaging the screed. Underfloor heating and screed commissioning must take place as per manufacturer's instructions and British Standards.

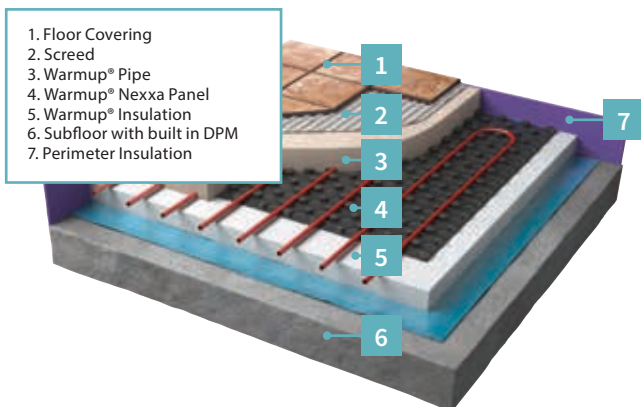



# Warmup® Forte Grid System

## *Screed and Concrete Floors*

The Forte Grid System is designed for installation into load-bearing structural floors.

The Forte Grid System incorporates wire grids to which the underfloor heating pipework is attached using cable ties.

The Forte Grid System is either located within a concrete or structural screed, but is suitable for almost any floor finish, in particular where the flooring is for a commercial application, such as epoxy paint or resin.

### Features

Pipework is fastened to the reinforced bars without impacting the integrity of the floor.

To ensure the most heat responsive floor, the pipe can be installed in the centre of the concrete zone.

**SAFETY Net™**  
Installation-Guarantee



When PEX-A  
Pipe is used



Other pipes carry  
50 year warranty

## Installation Guide

**(Refer to installation manual for complete instructions)**

Make a layout plan of your floor area by measuring your room and then subtract any fixtures (such as baths and cupboards).

Ensure the installation area is dry and sealed to the elements and that you have a level floor surface. If installation is to take place onto a concrete base, install Warmup's polyethylene damp proof membrane and assess whether supplementary insulation is required before installing a perimeter insulation to prevent heat loss. This allows for some subfloor expansion due to temperature

changes. Warmup® insulation panels are an integral part of the Tella Grid System, however, for new-build projects, additional insulation may be required to comply with building regulations, depending on the existing subfloor construction.

The Insulation boards are then laid over a compacted level bed of hardcore and fixed to the subfloor throughout the room before being covered with a plastic membrane.

The Forte Grids are then laid over the plastic membrane.

Warmup's heating pipe is then laid out according to a predesigned pattern, with the pipe being secured to the Forte Grid with plastic cable ties.

In some cases, an additional structural reinforcement grid can be added above the pipe for additional strength. This additional grid will normally be laid on castles to ensure the mesh is at the correct height ready for the screeding process.

Once installed, attach the pipe to the manifold and pressure test to ensure the system is working correctly; it should be left under pressure until the flooring process is complete.

### Completing the job

Once the system has been tested, the screed should be laid over the system as soon as possible to prevent damage to the pipe and to allow the drying process to begin. The screed must be allowed to dry naturally until full strength is reached before turning on the underfloor heating, unless the screed manufacturer's instructions say otherwise.

The heating system is then turned on, gradually increasing the temperature of the floor over a number of days until the desired temperature is reached. Turning on the system too early or too high will dry the screed too quickly, damaging the screed. Underfloor heating and screed commissioning must take place as per manufacturer's instructions and British Standards.

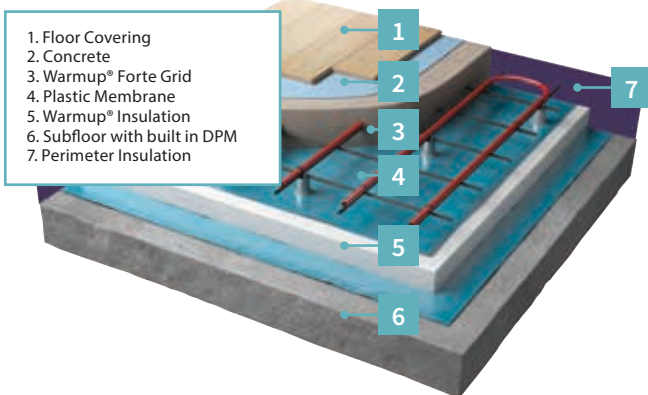



# Warmup® Econna Joisted Floor System

*Timber Suspended and Batten Floors*

The Econna Joisted Floor System is a composite 22mm wooden slotted floor with return ends designed to withstand heavy loads.

It is designed to fit on top of standard wood joists of 400mm to 600mm c/c max. This replaces the standard board in the floor construction.

The Econna Joisted Floor System is suitable for almost any floor finish, in particular where the flooring (wood, carpet or vinyl) may be replaced from time to time.

Features
Pipe is built into the structural floor, allowing faster heat-up response times.
No screeding required.



When PEX-A Pipe is used



Other pipes carry 50 year warranty

## Installation Guide

**(Refer to installation manual for complete instructions)**

Make a layout plan of your floor area by measuring your room and then subtract any fixtures (such as baths and cupboards).

Before commencing installation, assess whether supplementary insulation is required. Although insulation is an integral part of the Econna System, it may not fully comply with Building Regulations

for new-build projects; additional insulation may be required, depending on the existing subfloor construction.

Rigid insulation of the required depth is placed between the joists before laying the Econna routed flooring layer. The Econna routed flooring layer is then screwed to the joists avoiding the pre-routed groves.

Warmup aluminium diffusion plates are then laid on top of the Econna routed flooring layer in the straight grooves only, leaving the return grooves bare.

The Warmup Pipe is then fitted into the Diffusion Plate and Econna Routed groves according to a predesigned pattern.

Once installed, attach the pipe to the manifold and conduct as pressure test to ensure the system is working correctly; it should be left under pressure until the flooring process is complete.

### Completing the job

Once the system has been tested, the final flooring should be laid over the system as soon as possible to prevent damage to the pipe.

The heating system is then turned on, gradually increasing the temperature of the floor over a number of days until the desired temperature is reached. Turning on the system too early or too high will damage the flooring.

Design parameters should not be exceeded and specific manufacturer's information should be adhered to.

1. Timber Floor Covering (18mm minimum)
2. Optional Thin Wood Floor Underlay
3. Warmup® Diffusion Plate
4. Warmup® Pipe
5. Warmup® Econna Routed Flooring
6. Joists
7. Insulation

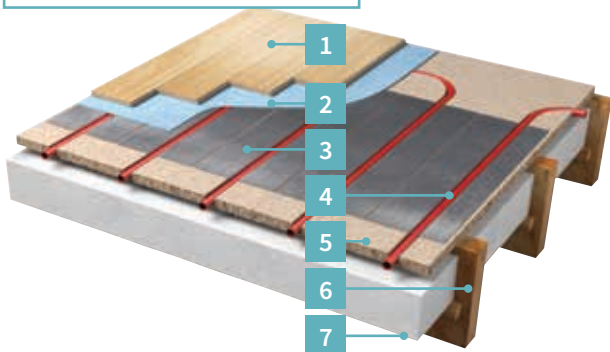



# Warmup® Silva Joisted Floor System

*Timber Suspended and Batten Floors*

The Silva Joisted Floor System is installed in many refurbishment projects.

Joists traditionally tend to be installed at 400mm centres. However, Warmup® can supply a more bespoke system to suit individual properties with varying joist centres as required.

The Silva Joisted Floor System is suitable for almost any floor finish, in particular where the flooring is wood or engineered wood.

## Features

Suitable for use under existing wooden floors

System installed between floor joists

Does not impact on floor heights

Lightweight screed provides fast heat-up response times

**SAFETY Net™**  
Installation-Guarantee



When PEX-A Pipe is used



Other pipes carry 50 year warranty

## Installation Guide

**(Refer to installation manual for complete instructions)**

Make a layout plan of your floor area by measuring your room and then subtract any fixtures (such as baths and cupboards).

The Clypso insulation for the Silva Joisted Floor system is installed between the existing joists using battens or noggins to hold the insulation in place. The Clypso insulation should be fitted tight to the joists without any gaps and should cover the entire floor area,

providing an insulated surface for pipe installation. Any holes or gaps that cannot be covered by the insulating panels should be filled using expanding foam.

The height of the Clypso Insulation panels should be set so that the top of the panels are in accordance with the system design, allowing for proper coverage of the pipe by the lightweight screed and to finish level with the joists.

In order to feed the pipe across a joist, a notch is cut into the top of the joist.

Once the Clypso Insulation panels are in place, the pipe circuits can be installed according to a pre-designed pattern using a purpose-built clip gun and Warmup clips.

Before the screed is poured, the Warmup pipe is attached to the manifold and pressure tested to ensure the system is working correctly; it is then left under pressure until the flooring process is complete.

### Completing the job

Once the system has been tested, the screed should be laid over the system as soon as possible to prevent damage to the pipe and to allow the drying process to begin.

The screed should be level with the top of the joists and must be allowed to dry naturally until full strength is reached before installing the floor covering.

The heating system is then turned on, gradually increasing the temperature of the floor over a number of days until the desired temperature is reached. Turning on the system too early or too high will dry the screed too quickly, damaging the screed.

Underfloor heating and screed commissioning must take place as per manufacturer's instructions and British Standards.

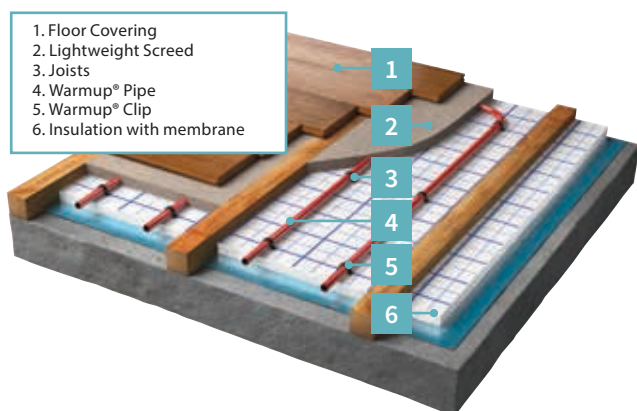



# Warmup® Tectora Joisted Batten Floor System

*Timber Suspended and Batten Floors*

The Tectora Joisted Batten Floor System is particularly suitable where there is a sprung/cradled battened floor or floor joists. It can be used in battened installations over a concrete subfloor, variable height floor battens are employed to create a void of between 50 -100mm.

The batons can be sprung or on cradles to create an acoustic floor.

For this installation, a diffusion plate system is generally used if standard installation types are not suitable.

For installing as a joisted system, the rigid insulation is placed between the joists to support the diffusion plates, as they span the joists.

The Tectora Joisted Batten Floor System is suitable for almost any floor finish, in particular wood or engineered wood.

Features
Diffusion plates spread heat efficiently without increasing floor build-up
System promotes fast heat-up response times
No screeding required



When PEX-A Pipe is used



Other pipes carry 50 year warranty



# Installation Guide

## (Refer to installation manual for complete instructions)

Make a layout plan of your floor area by measuring your room and then subtract any fixtures (such as baths and cupboards).

Required battens to support the insulation will need to be designed and installed by the flooring contractor and co-ordinated with the installer of the Tectora System.

Ensure the installation area is dry, sealed to the elements and that you have a level floor surface. If installation is to take place onto a concrete base, install Warmup's polyethylene damp proof membrane.

You should assess whether supplementary insulation is required before installing a perimeter insulation to prevent heat loss, allowing for some subfloor expansion due to temperature changes. Although insulation is an integral part of the Tectora System it may not fully comply with Building Regulations for new-build projects; additional insulation may be required, depending on the existing subfloor construction.

Rigid insulation of the required depth is placed between the preinstalled battens before fixing the Tectora diffusion plates to the battens with screws. The Warmup® pipe is then fitted into the Tectora diffusion plates groove according to a predesigned pattern. Once installed, attach the pipe to the manifold and pressure test to ensure the system is working correctly; it should be left under pressure until the flooring process is complete.

## Completing the job

Once the system has been tested, the final flooring should be laid over the system as soon as possible to prevent damage to the pipe.

The heating system is then turned on, gradually increasing the temperature of the floor over a number of days until the desired temperature is reached. Turning on the system too early or too high will damage the flooring.

Design parameters should not be exceeded and specific manufacturer's information should be adhered to.

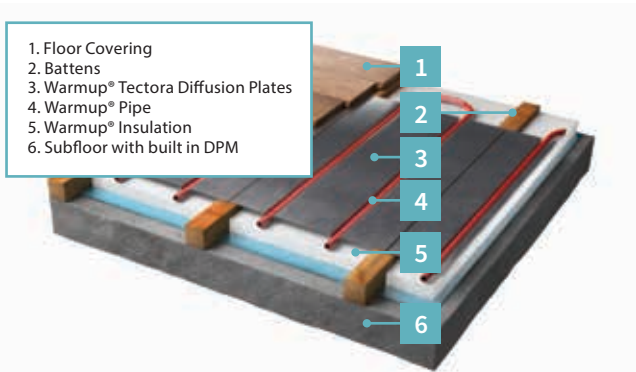



# Warmup® Contura Floating Floor System

*Timber Suspended and Batten Floors*

The Contura Floating Floor System (combines preformed insulation and diffusion plates) is used where heating is installed onto a concrete or solid wooden subfloor but where a dry finish is used in place of a standard screed covering.

This system typically has a lower wattage per square metre output (75w/m<sup>2</sup>) compared to traditional screeded floors.

It is used primarily in new build on upper floors where insulation levels are higher, lowering the heat requirements.

It is suitable in refurbishment projects where sufficiently increased levels of insulation is applied. It can be installed under almost any floor finish, in particular engineered wood and composite laminate wood.

## Features

Comprehensive choice of board strengths and thickness available to match individual requirements

Overlay system requires no screeding

System promotes fast heat-up response times

**SAFETY Net™**  
Installation-Guarantee



When PEX-A Pipe is used



Other pipes carry 50 year warranty

# Installation Guide

## (Refer to installation manual for complete instructions)

Make a layout plan of your floor area by measuring your room and then subtract any fixtures (such as baths and cupboards).

Ensure the installation area is dry and sealed to the elements and that you have a level floor surface. As the Contura Floating Floor System is installed directly onto a concrete base, install Warmup's polyethylene damp proof membrane, assess whether supplementary insulation is required. Insulation is an integral part of the Contura System, but may not fully comply with Building Regulations for new-build projects; additional insulation may be required, depending on the existing subfloor construction.

Lay the Contura Insulation directly onto the concrete subfloor before fitting Warmup's diffusion plates in the straight grooves of the insulation only, leaving the return grooves clear.

Carefully insert the Warmup® pipe into the pre-moulded Contura grooves according to a predesigned pattern until your desired heated area is covered.

Once installed, attach the pipe to the manifold and pressure test to ensure the system is working correctly; it should be left under pressure until the flooring process is complete.

### Completing the job

Once the system has been tested, the final flooring should be laid over the system as soon as possible to prevent damage to the pipe.

The heating system is then turned on, gradually increasing the temperature of the floor over a number of days until the desired temperature is reached. Turning on the system too early or too high will damage the flooring.

Design parameters should not be exceeded.  
Manufacturer's instructions must be followed.

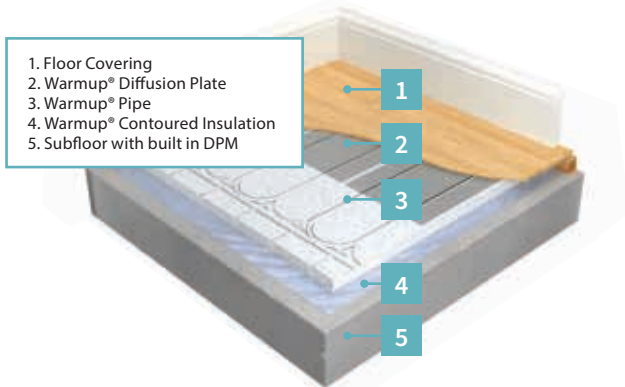



# Warmup® Total-16 Low Profile System

*Insulation*

**NEW!**

Total-16 is a low build (16mm), no screed required, lightweight yet heavy-duty hydronic insulation system with inbuilt diffusion plate.

The system is designed for use with Warmup's 12mm PEX-A pipe, which is inserted into the insulation boards. Warmup's 12mm PEX-A pipe is at the heart of the low profile system because it is strong, flexible and kink resistant and it comes with our best warranty and guarantee.

With Total-16's build-up of only 16mm and the straight boards supplied with integrated aluminium heat diffuser plates, the installation time is significantly reduced. This makes Total-16 ideal for new-build and refurbishment projects where floor height is at a premium and installation speed is of the essence.

Total-16 is installed onto either concrete or wooden sub-floors and can be used under almost any floor finish, including solid and engineered wood, ceramic, stone floors as well as vinyl and carpet.

Total-16 is comprised of straight boards, with integrated aluminium plates, multi-feed boards and return boards. These boards are made of a high density EPS and can support 40 tonnes/m<sup>2</sup>.

Features	Specification
Suitable for almost any floor finish, including tiles	Thermal conductivity: 0.034 W/mK @ 10° C
Ultra low weight - only 1.7 Kg for the straight, multi-feed and return boards	Compressive strength: 400kPa (40 tonnes/m <sup>2</sup> )
Ultra low height - only 16mm	Thermal output: Up to 111 W/m <sup>2</sup>
Aluminium heat diffusion plates are pre-installed, reducing installation time	Straight boards are moulded at 150mm pipe centres
Can be supplied with or without return ends	



**SAFETY Net™**  
Installation-Guarantee

# Installation Guide

## (Refer to installation manual for complete instructions)

Make a layout plan of your floor area by measuring your room and then subtract any fixtures (such as baths and cupboards).

Before commencing installation, assess whether supplementary insulation is required. Insulation is an integral part of the Warmup Total-16, but may not fully comply with Building Regulations for new-build projects.

Ensure the installation area is dry, level and sealed from the elements. In most cases Total-16 can be laid as a floating floor, but for tiled flooring or vinyl flooring in wet areas, the Total-16 boards must be fixed to the subfloor using Seal Adhesive or Glue (see p102).

When tiling on Total-16, the boards and aluminium plates must be primed using Warmup's WHS-X-Primer. For heavy footfall areas, tiling directly onto the Total-16 boards is not recommended.

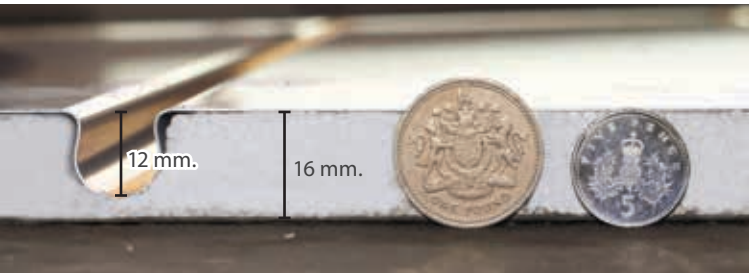

Lay the Total-16 low profile system to match the layout plan. Carefully insert the PEX-A 12mm pipe into the pre-moulded grooves until your desired heated area is covered.

Then attach the 12mm PEX-A pipe to the flow connection on the manifold - use the Warmup pipe bend support (WHS-P-BEND12) to hold the pipe at a 90° angle. Following a single meander pattern, install the pipe in the boards by pushing into the grooves of the heat diffuser plates. Finally, fix another pipe bend support to the return pipe and connect to the manifold.

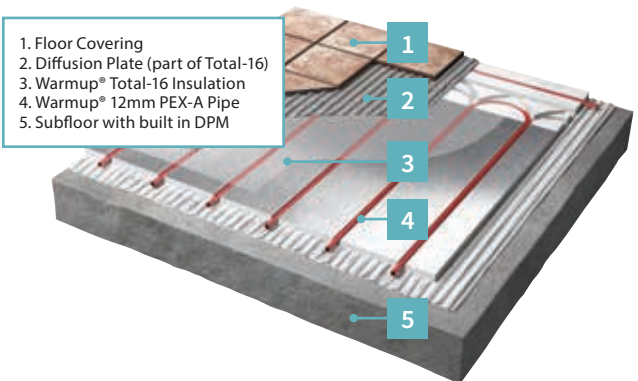



# Warmup® Dual Overlay Concrete

## *Screed Replacement Board*

Dual Overlay Concrete is a fast track floor preparation system for use as a screed replacement system which can be installed over the Econna, Contura and Total-16 hydronic systems. It is suitable for installation under many floor coverings such as tiles, wood and resilient floors.

Installation is quick, clean and dry making it an easier option for installers. The low heat resistance allows heat to pass through the floor finish without any reduction to the efficiency, evenly distributing the heat and alleviating any hot spots.

Dual Overlay Concrete consists of a base and top board. Both boards are provided with contact adhesive, bonding them together to make one solid subfloor.

### Features

- Provides a stable subfloor on which a variety of floor coverings can be laid
- Suitable for our Econna & Contura hydronic underfloor heating systems
- Installation is quick and easy
- Provides even heat distribution

### Technical Data

Size	1,200mm x 600mm
Thickness	2 x 6mm
Composition	Cement, Silica (quartz), Cellulose and filling material, fitted with an interactive adhesive
Weight per panel (kg)	7.5
Weight per m <sup>2</sup> (kg)	21
Tog	0.4
Thermal Rm value (m <sup>2</sup> .K.W.-1)	0.038
Fire Class	EN 13501: 2007 B <sub>fl,s1</sub>

# Installation Guide

(Refer to installation manual for complete instructions)

The Warmup® Dual Overlay is comprised of a 6mm deep cement bottom board and 6mm deep cement top board. The bottom and top layers are laid out with staggered joints and arranged so that the top boards overlap the joints in the base boards. The Warmup® Hydronic Heating System lays below a decoupling layer and the Dual Overlay Concrete System. This method of installation provides a stable surface for the floor finish to rest on and avoid any joints showing through the final floor finish. Finally, the floor finish can either be glued to the boards as a final layer or simply laid freely upon them.

## Floor Cutaway - Based on Econna Installation

### Dual Overlay Concrete with Floating Wood Floor

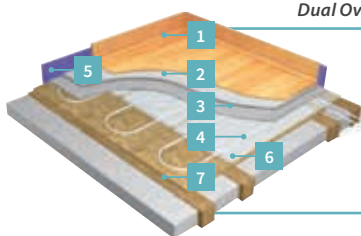

1. Floating Wood Floor (18mm maximum)
2. Optional Thin Wood Floor Underlay
3. Dual Over Lay Concrete Boards
4. Warmup® Pipe
5. Perimeter Strip
6. Decoupling Layer
7. Econna Underfloor Heating System

### Dual Overlay Concrete with Glued Wood Floor

1. Glued Wood Floor
2. Fixed 8mm Chipboard Layer
3. Dual Over Lay Concrete Boards
4. Warmup® Pipe
5. Perimeter Strip
6. Decoupling Layer
7. Econna Underfloor Heating System

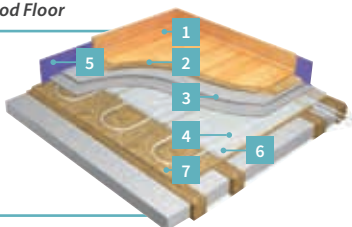

### Dual Overlay Concrete with Tiled Floor

1. Tiled floor
2. Flexible tile adhesive with glassfibre mesh
3. Dual Over Lay Concrete Boards
4. Warmup® Pipe
5. Perimeter Strip
6. Decoupling Layer
7. Econna Underfloor Heating System

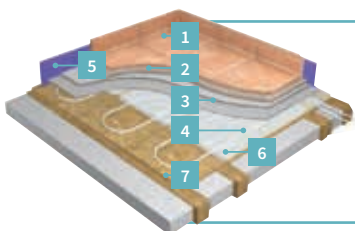

### Dual Overlay Concrete with Resilient Floor

1. Resilient Floor Covering
2. Thinset fibre-reinforced screed
3. Dual Over Lay Concrete Boards
4. Warmup® Pipe
5. Perimeter Strip
6. Decoupling Layer
7. Econna Underfloor Heating System

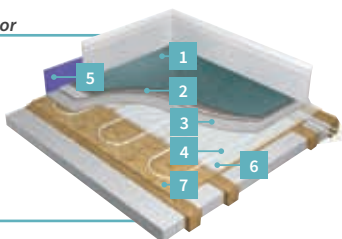

## Warmup® HydroPack

### WARMUP HYDROPACK INSTALLATION KIT

	CODE	DESCRIPTION	RRP (Excl. VAT)	PACK QTY
	WHS-HYDRO PACK-22	HydroPack Installation Kit for projects up to 22m <sup>2</sup>	£715.24	1

### A RATED SINGLE ROOM / ZONE MANIFOLD WITH PUMP / MIXING UNIT



	CODE	DESCRIPTION	RRP (Excl. VAT)	PACK QTY
	WHS-M-S- RM01	A Rated Single Room / Zone Manifold with Pump / Mixing unit	£535.71	1

## Warmup® Thermostats

### 4iE ENERGY-MONITOR THERMOSTAT



	CODE	DESCRIPTION	RRP (Excl. VAT)	PACK QTY
	4iE™ OB	Onyx Black Programmable Thermostat	£179.16	1
	4iE™ BP	Bright Porcelain Programmable Thermostat	£179.16	1

### 4iE +KIT



	CODE	DESCRIPTION	PRICE (Excl. VAT)	PACK QTY
	4iE Plus Kit	Warmup +Kit (for use with Warmup 4iE)	£70.83	1

### 3iE® ENERGY-MONITOR THERMOSTAT



	CODE	DESCRIPTION	RRP (Excl. VAT)	PACK QTY
	3iE™ PB	Piano Black Programmable Thermostat	£137.49	1
	3iE™ CC	Classic Cream Programmable Thermostat	£137.49	1
	3iE™ SG	Silver Grey Programmable Thermostat	£145.83	1
	3iE™ LG	Leaf Green Programmable Thermostat	£145.83	1
	3iE™ MB	Madison Blue Programmable Thermostat	£145.83	1
	3iE™ DP	Deep Pink Programmable Thermostat	£145.83	1
	3iE™ WB	Warm Berry Programmable Thermostat	£145.83	1

### TEMPO DIGITAL THERMOSTAT



	CODE	DESCRIPTION	RRP (Excl. VAT)	PACK QTY
	ELT PB	Tempo - Piano Black	£95.83	1
	ELT PW	Tempo - Porcelain White	£95.83	1



# J Range Thermostats & Controls For Heating & Cooling

## 4-EVENT TIMER THERMOSTAT



CODE	DESCRIPTION	RRP (Excl. VAT)	PACK QTY
WHS-J-4ET	4 event timer thermostat	£185.63	1

## STANDARD AMBIENT DIAL SENSOR



CODE	DESCRIPTION	RRP (Excl. VAT)	PACK QTY
WHS-J-SEN-A	Standard ambient dial sensor	£65.30	1

## 240V BMS DIGITAL MASTER WIRING CENTRE



CODE	DESCRIPTION	RRP (Excl. VAT)	PACK QTY
WHS-J-BMSDWC	240v BMS Digital master wiring centre	£867.29	1
WHS-J-DWC	240v Digital master wiring centre	£722.74	1

## 240V STANDARD MASTER WIRING CENTRE



CODE	DESCRIPTION	RRP (Excl. VAT)	PACK QTY
WHS-J-SWC	240v Standard Master wiring centre	£291.79	1

## EXTENSION KIT TO CONNECT CAT5E CABLING TO WIRING CENTRES



CODE	DESCRIPTION	RRP (Excl. VAT)	PACK QTY
WHS-J-EK	Extension kit to connect Cat5e cabling to wiring centres	£26.55	1

## HUMIDITY SENSOR FOR HYDRONIC SYSTEMS



CODE	DESCRIPTION	RRP (Excl. VAT)	PACK QTY
WHS-J-SEN-H	Humidity sensor for hydronic systems	£159.14	1

## HEATING/COOLING SWITCH FOR HYDRONIC SYSTEMS



CODE	DESCRIPTION	RRP (Excl. VAT)	PACK QTY
WHS-J-SWITCH	Heating/cooling switch for hydronic systems	£195.74	1

# S Range Thermostats & Controls

## DIGITAL ROOM THERMOSTAT FOR HYDRONIC SYSTEMS



CODE	DESCRIPTION	RRP (Excl. VAT)	PACK QTY
WHS-C-B-D230	Digital room thermostat for hydronic systems	£50.89	1

## 230V DUAL TEMP THERMOSTAT FOR HYDRONIC SYSTEMS



CODE	DESCRIPTION	RRP (Excl. VAT)	PACK QTY
WHS-C-B-M230	230v Dual temp thermostat for hydronic systems	£33.07	1

## 230V MASTER WIRING BOX 4 ZONE FOR HYDRONIC SYSTEMS



CODE	DESCRIPTION	RRP (Excl. VAT)	PACK QTY
WHS-C-B-MASTER01	230v Master wiring box 4 zone for hydronic systems	£64.86	1

## 230V 4 ZONE SLAVE UNIT FOR HYDRONIC SYSTEMS



CODE	DESCRIPTION	RRP (Excl. VAT)	PACK QTY
WHS-S-SLV4Z	230V 4 zone slave unit for hydronic systems	£48.36	1

## 230V 6 ZONE SLAVE UNIT FOR HYDRONIC SYSTEMS



CODE	DESCRIPTION	RRP (Excl. VAT)	PACK QTY
WHS-S-SLV6Z	230V 6 zone slave unit for hydronic systems	£55.79	1

## 230V TAMPERPROOF ROOM THERMOSTAT FOR HYDRONIC



CODE	DESCRIPTION	RRP (Excl. VAT)	PACK QTY
WHS-S-230TP	230v Tamperproof room thermostat for hydronic systems	£34.39	1

## WET AREA BOX & 3METRE CLASS 2 SENSOR 10K



CODE	DESCRIPTION	RRP (Excl. VAT)	PACK QTY
WHS-S-SEN	Wet Area Box & 3metre class 2 sensor 10k	£9.29	1

## 230V PLUG-IN TIMER FOR HYDRONIC SYSTEMS



CODE	DESCRIPTION	RRP (Excl. VAT)	PACK QTY
WHS-S-TIMER230	230v Plug-in timer for hydronic systems	£79.86	1

# Insulation & Routed Boards

Due to the nature of all insulation products, specific availability and shipping terms may apply.

Please contact us on 0345 034 8270 to confirm.

## CLYPSO INSULATION BOARD SYSTEMS



CODE	DESCRIPTION	RRP (Excl. VAT)	PACK QTY
WHS-CL-B07025	Clypso 25mm thickness gridded insulation board, EPS 070, 2.4m x 1.2m (pack of 12)	£134.14	12
WHS-CL-B07050	Clypso 50mm thickness gridded insulation board, EPS 070, 2.4m x 1.2m (pack of 6)	£99.64	6
WHS-CL-B07075	Clypso 75mm thickness gridded insulation board, EPS 070, 2.4m x 1.2m (pack of 4)	£88.29	4
WHS-CL-B07100	Clypso 100mm thickness gridded insulation board, EPS 070, 2.4m x 1.2m (pack of 3)	£82.50	3
WHS-CL-B10025	Clypso 25mm thickness gridded insulation board, EPS 100, 2.4m x 1.2m (pack of 12)	£177.43	12
WHS-CL-B10050	Clypso 50mm thickness gridded insulation board, EPS 100, 2.4m x 1.2m (pack of 6)	£143.36	6
WHS-CL-B10075	Clypso 75mm thickness gridded insulation board, EPS 100, 2.4m x 1.2m (pack of 4)	£131.86	4
WHS-CL-B10100	Clypso 100mm thickness gridded insulation board, EPS 100, 2.4m x 1.2m (pack of 3)	£126.11	3
WHS-CL-B07025+	Clypso 25mm thickness gridded insulation board, EPS 070, 2.4m x 1.2m Premium range (pack of 12)	£210.43	12
WHS-CL-B07050+	Clypso 50mm thickness gridded insulation board, EPS 070, 2.4m x 1.2m Premium range (pack of 6)	£175.93	6
WHS-CL-B07075+	Clypso 75mm thickness gridded insulation board, EPS 070, 2.4m x 1.2m Premium range (pack of 4)	£164.57	4
WHS-CL-B07100+	Clypso 100mm thickness gridded insulation board, EPS 070, 2.4m x 1.2m Premium range (pack of 3)	£158.79	3
WHS-CL-B10025+	Clypso 25mm thickness gridded insulation board, EPS 100, 2.4m x 1.2m Premium range (pack of 12)	£274.71	12
WHS-CL-B10050+	Clypso 50mm thickness gridded insulation board, EPS 100, 2.4m x 1.2m Premium range (pack of 6)	£240.21	6
WHS-CL-B10075+	Clypso 75mm thickness gridded insulation board, EPS 100, 2.4m x 1.2m Premium range (pack of 4)	£228.86	4
WHS-CL-B10100+	Clypso 100mm thickness gridded insulation board, EPS 100, 2.4m x 1.2m Premium range (pack of 3)	£223.07	3

## METRO / GENERAL INSULATION BOARD



CODE	DESCRIPTION	RRP (Excl. VAT)	PACK QTY
WHS-MT-B07025	Metro/General 25mm thickness insulation board, EPS 070, 2.4m x 1.2m (pack of 12)	£65.57	12
WHS-MT-B07050	Metro/General 50mm thickness insulation board, EPS 070, 2.4m x 1.2m (pack of 6)	£65.36	6
WHS-MT-B07075	Metro/General 75mm thickness insulation board, EPS 070, 2.4m x 1.2m (pack of 4)	£65.43	4
WHS-MT-B07100	Metro/General 100mm thickness insulation board, EPS 070, 2.4m x 1.2m (pack of 3)	£65.36	3
WHS-MT-B07025+	Metro/General 25mm thickness insulation board, EPS 070, 2.4m x 1.2m Premium range (pack of 12)	£141.86	12
WHS-MT-B07050+	Metro/General 50mm thickness insulation board, EPS 070, 2.4m x 1.2m Premium range (pack of 6)	£141.64	6
WHS-MT-B07075+	Metro/General 75mm thickness insulation board, EPS 070, 2.4m x 1.2m Premium range (pack of 4)	£141.71	4
WHS-MT-B07100+	Metro/General 100mm thickness insulation board, EPS 070, 2.4m x 1.2m Premium range (pack of 3)	£141.64	3
WHS-MT-B10025	Metro/General 25mm thickness insulation board, EPS 100, 2.4m x 1.2m (pack of 12)	£108.86	12
WHS-MT-B10050	Metro/General 50mm thickness insulation board, EPS 100, 2.4m x 1.2m (pack of 6)	£109.07	6
WHS-MT-B10075	Metro/General 75mm thickness insulation board, EPS 100, 2.4m x 1.2m (pack of 4)	£109.00	4
WHS-MT-B10100	Metro/General 100mm thickness insulation board, EPS 100, 2.4m x 1.2m (pack of 3)	£108.96	3
WHS-MT-B10025+	Metro/General 25mm thickness insulation board, EPS 100, 2.4m x 1.2m Premium range (pack of 12)	£206.14	12
WHS-MT-B10050+	Metro/General 50mm thickness insulation board, EPS 100, 2.4m x 1.2m Premium range (pack of 6)	£205.93	6
WHS-MT-B10075+	Metro/General 75mm thickness insulation board, EPS 100, 2.4m x 1.2m Premium range (pack of 4)	£206.00	4
WHS-MT-B10100+	Metro/General 100mm thickness insulation board, EPS 100, 2.4m x 1.2m Premium range (pack of 3)	£205.93	3

## NEXXA CASTELLATED SYSTEM

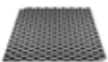

CODE	DESCRIPTION	RRP (Excl. VAT)	PACK QTY
WHS-TL-ALU10	Nexxa System plate with 10mm Insulation	£14.00	1

## CLYPSO INSULATION GRIDDED BOARD



CODE	DESCRIPTION	RRP (Excl. VAT)	PACK QTY
WHS-CL-RB25	Clypso 25mm Insulation Gridded PIR board	£52.79	1
WHS-CL-RB40	Clypso 40mm Insulation Gridded PIR board	£66.21	1
WHS-CL-RB50	Clypso 50mm Insulation Gridded PIR board	£77.89	1
WHS-CL-RB60	Clypso 60mm Insulation Gridded PIR board	£86.07	1
WHS-CL-RB75	Clypso 75mm Insulation Gridded PIR Board	£100.00	1

## METRO / GENERAL INSULATION PIR





CODE	DESCRIPTION	RRP (Excl. VAT)	PACK QTY
WHS-MT-INS25	Metro/General 25mm Insulation PIR - 2.4 x 1.2m	£36.36	1
WHS-MT-INS30	Metro/General 30mm Insulation PIR - 2.4 x 1.2m	£41.07	1
WHS-MT-INS35	Metro/General 35mm Insulation PIR - 2.4 x 1.2m	£43.46	1
WHS-MT-INS40	Metro/General 40mm Insulation PIR - 2.4 x 1.2m	£47.07	1
WHS-MT-INS45	Metro/General 45mm Insulation PIR - 2.4 x 1.2m	£53.00	1
WHS-MT-INS50	Metro/General 50mm Insulation PIR - 2.4 x 1.2m	£57.71	1
WHS-MT-INS60	Metro/General 60mm Insulation PIR - 2.4 x 1.2m	£68.93	1
WHS-MT-INS65	Metro/General 65mm Insulation PIR - 2.4 x 1.2m	£74.64	1
WHS-MT-INS70	Metro/General 70mm Insulation PIR - 2.4 x 1.2m	£80.79	1
WHS-MT-INS75	Metro/General 75mm Insulation PIR - 2.4 x 1.2m	£81.61	1
WHS-MT-INS80	Metro/General 80mm Insulation PIR - 2.4 x 1.2m	£87.71	1
WHS-MT-INS90	Metro/General 90mm Insulation PIR - 2.4 x 1.2m	£98.07	1
WHS-MT-INS100	Metro/General 100mm Insulation PIR - 2.4 x 1.2m	£108.50	1

## TOTAL-16 LOW PROFILE SYSTEM

	CODE	DESCRIPTION	RRP (Excl. VAT)	PACK QTY
	WHS-TOTAL16-BOARD	Total-16 Moulded Straight Board including Aluminium plate for Pex-A 12mm pipes. 600 x 1200 x 16mm	£39.99	1

	CODE	DESCRIPTION	RRP (Excl. VAT)	PACK QTY
	WHS-TOTAL16-RETURN	Total-16 Moulded Return Board for Pex-A 12mm pipes. 300 x 600 x 16mm	£6.66	1

	CODE	DESCRIPTION	RRP (Excl. VAT)	PACK QTY
	WHS-TOTAL16-FEED	Total-16 Moulded Feeding Board for Pex-A 12mm Pipes. 300 x 600 x 16mm	£6.66	1

	CODE	DESCRIPTION	RRP (Excl. VAT)	PACK QTY
	WHS-P-PEXA-12 X 70	Pipes Range - Pipe Pex-A 12mm x 2mm. Sold in lengths of 70m	£133.67	1
	WHS-P-PEXA-12 X140	Pipes Range - Pipe Pex-A 12mm x 2mm. Sold in lengths of 140m	£267.84	1

## WATER BASED GLUE

	CODE	DESCRIPTION	RRP (Excl. VAT)	PACK QTY
	WHS-X-Glue	10 Litre Water-based glue	£105.93	1

## EUROCONE CONNECTORS

	CODE	DESCRIPTION	RRP (Excl. VAT)	PACK QTY
	WHS-P-CONNECT12	12mm x 2mm eurocone connector	£2.50	1

## PIPE BEND SUPPORT FOR HYDRONIC SYSTEMS

	CODE	DESCRIPTION	RRP (Excl. VAT)	PACK QTY
	WHS-P-BEND12	Pipe bend support for 12mm pipes	£2	1

## DUAL OVERLAY CONCRETE

	CODE	DESCRIPTION	RRP (Excl. VAT)	PACK QTY
	WDOC	Dual Overlay Concrete System (covers 0.72m <sup>2</sup> )	£32	1

## CONTURA FLOATING PANEL - WITH RETURNS



CODE	DESCRIPTION	RRP (Excl. VAT)	PACK QTY
WHS-CO-P2030	Contura Floating 30mm Panel - 200mm Centres With Returns - 150 Grade	£16.36	1
WHS-CO-P2040	Contura Floating 40mm Panel - 200mm Centres With Returns - 150 Grade	£21.79	1
WHS-CO-P2050	Contura Floating 50mm Panel - 200mm Centres With Returns - 150 Grade	£27.25	1
WHS-CO-P2060	Contura Floating 60mm Panel - 200mm Centres With Returns - 150 Grade	£26.14	1
WHS-CO-P2070	Contura Floating 70mm Panel - 200mm Centres With Returns - 150 Grade	£30.50	1
WHS-CO-P2080	Contura Floating 80mm Panel - 200mm Centres With Returns - 150 Grade	£34.86	1
WHS-CO-P2090	Contura Floating 90mm Panel - 200mm Centres With Returns - 150 Grade	£39.25	1
WHS-CO-P2100	Contura Floating 100mm Panel - 200mm Centres With Returns - 150 Grade	£43.61	1

## ECONNA OVER JOIST FLOATING PANEL



CODE	DESCRIPTION	RRP (Excl. VAT)	PACK QTY
WHS-EC-CB22A	Econna Over Joist straight contour board - 600x1800x22	£38.86	1
WHS-EC-CB22AE	Econna Over Joist turn - 800 x 595 x 22mm	£22.36	1

## DIFFUSION PLATE 190 x 1000 x 0.5mm



CODE	DESCRIPTION	RRP (Excl. VAT)	PACK QTY
WHS-EC-PLT16	Diffusion plate 190 x 1000 x 0.5mm single channel (16mm pipe)	£4.68	1

## 5 LITRES OF FIX BINDER



CODE	DESCRIPTION	RRP (Excl. VAT)	PACK QTY
WHS-X-BIND	5 litres of fix binder	£62.21	1

## 3 LITRES OF START PRIMER



CODE	DESCRIPTION	RRP (Excl. VAT)	PACK QTY
WHS-X-PRIMER	3 litres of start primer	£62.21	1

## 20KG PACK OF SEAL ADHESIVE



CODE	DESCRIPTION	RRP (Excl. VAT)	PACK QTY
WHS-X-SEAL25	20kg pack of seal adhesive	£69.11	1

## Aluminium Diffuser Plates

DIFFUSION PLATE 390 x 1000 x 0.5 / 0.6 / 0.7 mm  
TWO GROOVE PLATES (16mm PIPE)



CODE	DESCRIPTION	RRP (Excl. VAT)	PACK QTY
WHS-TE-ALUDP1	Diffusion plate 390 x 1000 x 0.5mm two groove plates (16mm pipe)	£8.75	1
WHS-TE-ALUDP2	Diffusion plate 390 x 1000 x 0.6mm two groove plates (16mm pipe)	£10.36	1
WHS-TE-ALUDP3	Diffusion plate 390 x 1000 x 0.7mm two groove plates (16mm pipe)	£11.79	1

DIFFUSION PLATE 190 x 1000 x 0.6 / 0.7 mm PLATES  
(16mm PIPE)



CODE	DESCRIPTION	RRP (Excl. VAT)	PACK QTY
WHS-TE-ALUDP4	Diffusion plate 190 x 1000 x 0.6mm plates (16mm pipe)	£4.68	1
WHS-TE-ALUDP5	Diffusion plate 190 x 1000 x 0.7mm plates (16mm pipe)	£5.43	1

## Fixing & Ancillaries

TACKER GUN TO BE USED WITH TACKER CLIPS



CODE	DESCRIPTION	RRP (Excl. VAT)	PACK QTY
WHS-CL-FIXER	Tacker gun to be used with tacker clips)	£223.21	1

PIPE CUTTERS UP TO 25mm PIPE DIAMETER



CODE	DESCRIPTION	RRP (Excl. VAT)	PACK QTY
WHS-P-CUT25	Pipe Cutters up to 25mm pipe diameter	£7.11	1

PIPE CUTTERS UP TO 36mm PIPE DIAMETER



CODE	DESCRIPTION	RRP (Excl. VAT)	PACK QTY
WHS-P-CUT36	Pipe cutters up to 36mm pipe diameter	£10.39	1

PIPE DECOILER



CODE	DESCRIPTION	RRP (Excl. VAT)	PACK QTY
WHS-P-DECOILER	Pipe decoiler	£314.79	1

CALIBRATION TOOL



CODE	DESCRIPTION	RRP (Excl. VAT)	PACK QTY
WHS-P-FORM	Calibration tool	£1.88	1



## PIPE BEND SUPPORT FOR HYDRONIC SYSTEMS



CODE	DESCRIPTION	RRP (Excl. VAT)	PACK QTY
WHS-P-BEND	Pipe bend support for hydronic systems	£1.48	1

## 45/100mm SINGLE CLIPS (100 PER BAG) FOR HYDRONIC SYSTEMS



CODE	DESCRIPTION	RRP (Excl. VAT)	PACK QTY
WHS-CL-P45	45mm single clips (100 per bag) for hydronic systems	£4.93	100
WHS-CL-P65	65mm single clips (100 per bag) for hydronic systems	£6.71	100

## 25mm PIPE CONDUIT PROTECTION 50m



CODE	DESCRIPTION	RRP (Excl. VAT)	PACK QTY
WHS-CL-CONDUIT	25mm pipe conduit protection 50m for hydronic systems	£70.71	1

## 40 & 60mm CLYPSO CLIPS FOR HYDRONIC SYSTEMS



CODE	DESCRIPTION	RRP (Excl. VAT)	PACK QTY
WHS-CL-T40	40mm tacker clips (300 per box)	£16.86	300
WHS-CL-T60	60mm Clypso clips (300 per box) for hydronic systems	£10.46	300

## TIES FOR MESH SYSTEM TO HOLD PIPE TO MESH (CABLE TIES)



CODE	DESCRIPTION	RRP (Excl. VAT)	PACK QTY
WHS-FO-TIE	Ties for Mesh system to hold pipe to mesh (cable ties) - 100/bag	£1.39	100

## CLIPRAIL FOR HYDRONIC SYSTEMS (SOLD PER UNIT)



CODE	DESCRIPTION	RRP (Excl. VAT)	PACK QTY
WHS-MT-RAIL01	Cliprail for hydronic systems (sold per unit)	£2.03	1

## NAIL CLIP 16mm FOR JOISTS (100 PER BOX)



CODE	DESCRIPTION	RRP (Excl. VAT)	PACK QTY
WHS-SI-N16	Nail clip 16mm for joists (100 per box)	£9.39	100

## PERIMETER STRIP FOR HYDRONIC SYSTEMS



CODE	DESCRIPTION	RRP (Excl. VAT)	PACK QTY
WHS-X-EDGE50	Perimeter strip for hydronic systems (8mm x 150mm x 50m)	£35.71	1

## POLYTHENE DPM FOR HYDRONIC SYSTEMS



CODE	DESCRIPTION	RRP (Excl. VAT)	PACK QTY
WHS-X-POL500	Polythene dpm 500g (4m x 50m)	£68.57	1
WHS-X-POL1200	Polythene dpm 1200g (4m x 25m)	£81.61	1

## CABINETS



CODE	DESCRIPTION	RRP (Excl. VAT)	PACK QTY
WHS-Cabinet400	Manifold Cabinet 400/640/130mm	£69.88	1
WHS-Cabinet450	Manifold Cabinet 450/640/130mm	£71.76	1
WHS-Cabinet530	Manifold Cabinet 530/640/130mm	£79.26	1
WHS-Cabinet680	Manifold Cabinet 680/640/130mm	£91.58	1
WHS-Cabinet830	Manifold Cabinet 830/640/130mm	£104.32	1
WHS-Cabinet1030	Manifold Cabinet 1030/640/130mm	£116.64	1
WHS-Cabinet1130	Manifold Cabinet 1130/640/130mm	£124.97	1

## Stainless Steel Manifolds / Ancillaries

### WARMUP STAINLESS STEEL MAINFOLD



CODE	DESCRIPTION	RRP (Excl. VAT)	PACK QTY
WHS-M-S3-02	Warmup Stainless Steel Manifold - 2 zone	£128.93	1
WHS-M-S3-03	Warmup Stainless Steel Manifold - 3 zone	£150.89	1
WHS-M-S3-04	Warmup Stainless Steel Manifold - 4 zone	£171.14	1
WHS-M-S3-05	Warmup Stainless Steel Manifold - 5 zone	£192.18	1
WHS-M-S3-06	Warmup Stainless Steel Manifold - 6 zone	£215.18	1
WHS-M-S3-07	Warmup Stainless Steel Manifold - 7 zone	£236.11	1
WHS-M-S3-08	Warmup Stainless Steel Manifold - 8 zone	£257.14	1
WHS-M-S3-09	Warmup Stainless Steel Manifold - 9 zone	£285.25	1
WHS-M-S3-10	Warmup Stainless Steel Manifold - 10 zone	£301.32	1
WHS-M-S3-11	Warmup Stainless Steel Manifold - 11 zone	£319.79	1
WHS-M-S3-12	Warmup Stainless Steel Manifold - 12 zone	£343.57	1

## AUTO AIR VENT



CODE	DESCRIPTION	RRP (Excl. VAT)	PACK QTY
WHS-M-B-VENT	Auto Air Vent for Hydronic System	£6.07	1

## 22mm 2 PORT VALVE FOR ZONING OF MANIFOLDS AND HEATING SYSTEMS



CODE	DESCRIPTION	RRP (Excl. VAT)	PACK QTY
WHS - ZONE VALVE 2 PORT	22mm 2 port valve for zoning of manifolds and heating systems	£62.50	1

## EUROCONE CONNECTORS



CODE	DESCRIPTION	RRP (Excl. VAT)	PACK QTY
WHS-P-CONNECT	16mm x 2mm eurocone connector for hydronic systems	£2.50	1

## 230V ACTUATOR FOR HYDRONIC SYSTEMS



CODE	DESCRIPTION	RRP (Excl. VAT)	PACK QTY
WHS-M-S3-ACT230	230v Actuator for Hydronic Systems	£25.21	1

## WARMUP HYDRONIC MIXING UNIT



CODE	DESCRIPTION	RRP (Excl. VAT)	PACK QTY
WHS-M-S3-MIX	Warmup Hydronic Mixing Unit	£428.57	1

## MANIFOLD VALVE KIT - 1" ISOLATING VALVE PAIR, 1" UNIONS AND 22MM COMPRESSION FITTINGS



CODE	DESCRIPTION	RRP (Excl. VAT)	PACK QTY
WHS-M-S3-VALVES	Manifold valve kit - 1" isolating valve pair, 1" unions and 22mm compression fittings	£36.00	1

## DYNACON MANIFOLD



CODE	DESCRIPTION	RRP (Excl. VAT)	PACK QTY
WHS-M-D-02	Dynacon manifold - 2 zone	£171.00	1
WHS-M-D-03	Dynacon manifold - 3 zone	£220.60	1
WHS-M-D-04	Dynacon manifold - 4 zone	£266.80	1
WHS-M-D-05	Dynacon manifold - 5 zone	£320.48	1
WHS-M-D-06	Dynacon manifold - 6 zone	£363.68	1
WHS-M-D-07	Dynacon manifold - 7 zone	£415.80	1
WHS-M-D-08	Dynacon manifold - 8 zone	£457.80	1
WHS-M-D-09	Dynacon manifold - 9 zone	£509.80	1
WHS-M-D-10	Dynacon manifold - 10 zone	£555.40	1
WHS-M-D-11	Dynacon manifold - 11 zone	£602.20	1
WHS-M-D-12	Dynacon manifold - 12 zone	£650.20	1



# Pipes

## WARMUP® PEX-A PIPE 16mm x 2mm



CODE	DESCRIPTION	RRP (Excl. VAT)	PACK QTY
WHS-P-PEXA-25	PEX-A 16mm x 2mm x 25m	£32.61	1
WHS-P-PEXA-50	PEX-A 16mm x 2mm x 50m	£65.22	1
WHS-P-PEXA-60	PEX-A 16mm x 2mm x 60m	£78.27	1
WHS-P-PEXA70	PEX-A 16mm x 2mm x 70m	£91.31	1
WHS-P-PEXA-80	PEX-A 16mm x 2mm x 80m	£104.36	1
WHS-P-PEXA-90	PEX-A 16mm x 2mm x 90m	£117.40	1
WHS-P-PEXA-100	PEX-A 16mm x 2mm x 100m	£130.45	1
WHS-P-PEXA-110	PEX-A 16mm x 2mm x 110m	£143.49	1
WHS-P-PEXA120	PEX-A 16mm x 2mm x 120m	£156.54	1
WHS-P-PEXA200	PEX-A 16mm x 2mm x 200m	£382.44	1
WHS-P-PEXA-300	PEX-A 16mm x 2mm x 300m	£573.48	1
WHS-P-PEXA-500	PEX-A 16mm x 2mm x 500m	£652.23	1

## WARMUP® PE-RT PIPE 16mm x 2mm



CODE	DESCRIPTION	RRP (Excl. VAT)	PACK QTY
WHS-P-PERT-25	PE-RT 16mm x 2mm x 25m	£23.68	1
WHS-P-PERT-50	PE-RT 16mm x 2mm x 50m	£47.37	1
WHS-P-PERT-60	PE-RT 16mm x 2mm x 60m	£56.84	1
WHS-P-PERT-70	PE-RT 16mm x 2mm x 70m	£66.31	1
WHS-P-PERT-80	PE-RT 16mm x 2mm x 80m	£75.79	1
WHS-P-PERT-90	PE-RT 16mm x 2mm x 90m	£85.26	1
WHS-P-PERT-100	PE-RT 16mm x 2mm x 100m	£94.73	1
WHS-P-PERT-110	PE-RT 16mm x 2mm x 110m	£104.21	1
WHS-P-PERT-120	PE-RT 16mm x 2mm x 125m	£113.68	1
WHS-P-PERT-300	PE-RT 16mm x 2mm x 300m	£305.63	1
WHS-P-PERT-500	PE-RT 16mm x 2mm x 500m	£473.66	1

## WARMUP® PE-RT/AL/PE-RT 16mm x 2mm



CODE	DESCRIPTION	RRP (Excl. VAT)	PACK QTY
WHS-P-ALPERT-100	ALPERT 16mm x 2mm, 100m	£153.60	1
WHS-P-ALPERT-200	ALPERT 16mm x 2mm, 200m	£307.14	1
WHS-P-ALPERT-500	ALPERT 16mm x 2mm, 500m	£767.86	1





## Global Projects Division

*Warmup® offers a dedicated team of Project Managers to help you throughout each stage of your project by allocating a dedicated Project Manager to support you from specifying and fitting, through to pre and post-installation.*

### Our Approach

- Upon receipt of your instructions and/or plans you will be assigned a dedicated in-house Project Manager
- Your Project Manager will contact you to review your project to ensure we have a complete understanding of your needs and the issues affecting your project
- Upon receipt of all relevant project information including details of floor build up and final floor surface, a quotation will be turned around within 24 hours. Complex projects will take longer
- Where appropriate we will provide advice, guidance and support both on and off-site where potential risks can be identified and prevented
- Provide the highest quality of products and services that are tailored to meet your specific requirements, adhering to best practice at the right price and at the right time.



## Design Process

Warmup® products and solutions adhere to industry standards, government legislation and Building Regulations. The project team, led by your dedicated Project Manager, will always recommend the best underfloor heating solution for your project, mindful of the need to keep to your specification, time schedule and budget.

Warmup will provide complete layouts to ensure there is a precise installation and zone control to the required area.

Working in collaboration with you, we will ensure co-ordination with the layouts and any integrated interior designs.

### **Warmup® provides quality products and services and will:**

- Only promise what we can deliver
- Deliver on what we promise
- Always remember that the products and services offered and installed by Warmup stand for quality

### **We are committed to providing an excellent level of service and aim to deliver this by:**

- Focusing on your needs when recommending solutions, planning and delivering services
- Applying the same standard of customer care to all our customers, whilst recognising that customers have individual needs

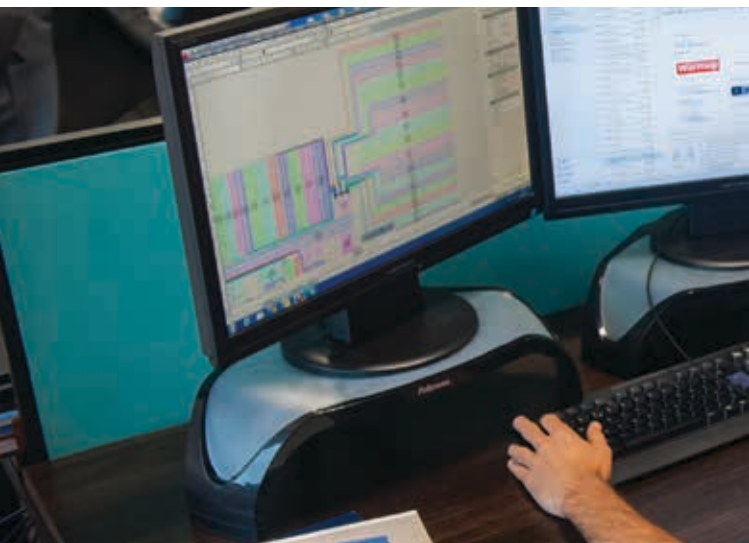



## The following standards indicate the minimum level of service customers can expect when dealing with Warmup

- Requests for quotations will be sent an automatic response acknowledging your request
- We will give you the name of the dedicated Project Manager who has been assigned your enquiry and we will give you an indication of when you can expect to receive a response
- Should you request us to contact you via telephone, we will agree with you the best time to do so

## Every Warmup® quotation will include a detailed summary of the project in which we will break down:

- The total gross and heated areas
- The total heat load and amperage required
- A detailed list of the items required with relevant technical data supported by illustrations of every item specified, including the controls and details of the supporting Guarantees and Warranties

Once we have been awarded the contract and/or purchase order, your dedicated Project Manager will continue to work closely with you to see your project through to a successful conclusion.

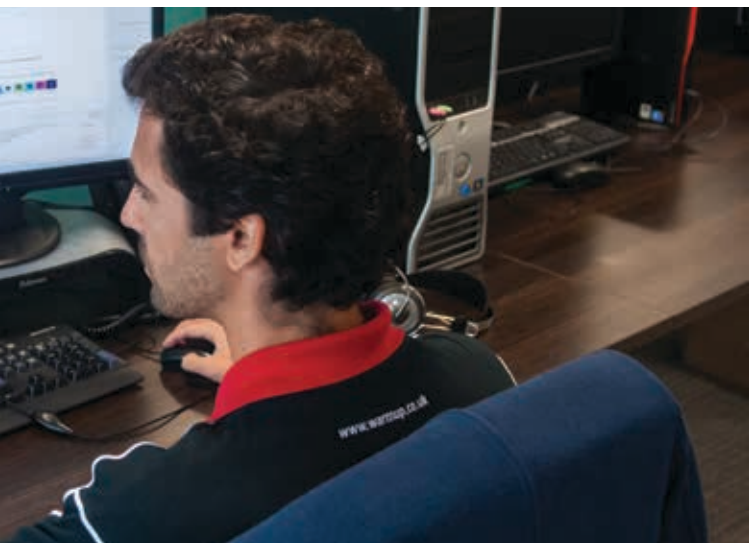

## Technical Support

We will support you pre and post sales/installation by offering you telephone support.

We offer online 'live' chat between 08.00 and 17.30hrs Monday to Friday. This is in addition to installation manuals and access to online tutorial videos.

We offer a SafetyNet™ Installation Guarantee. Should you (or your installer) accidentally damage a heating system (wire or pipe) during installation, we will replace it free of charge.

If a floor(s) is damaged post installation (i.e. by drilling through a pipe or wire), we offer a dedicated team of service engineers.

### For more information or to submit plans:

**Call: 0345 345 2288**

**Email: [uk@warmup.com](mailto:uk@warmup.com)**

**Fax: 0345 345 2299**

**Visit [www.warmup.co.uk](http://www.warmup.co.uk)**

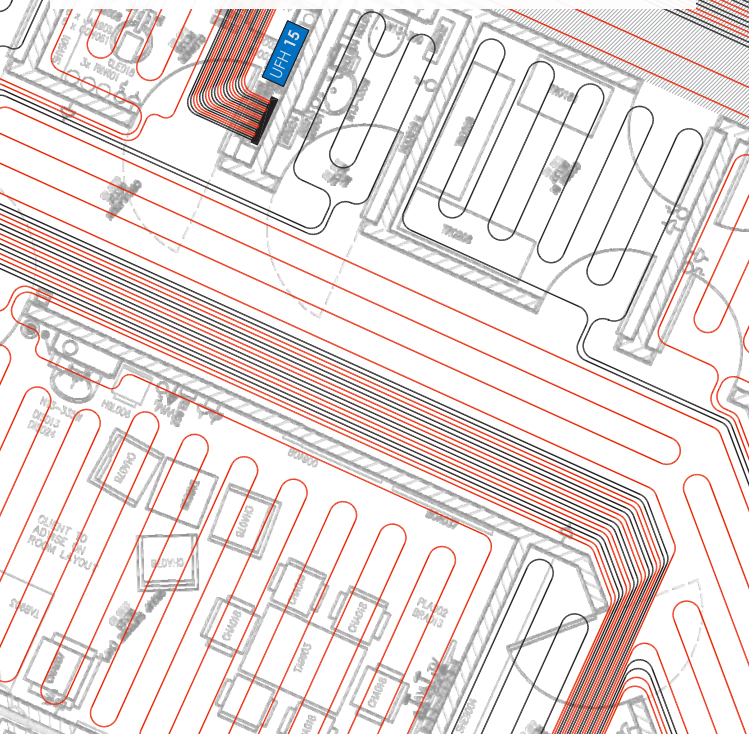

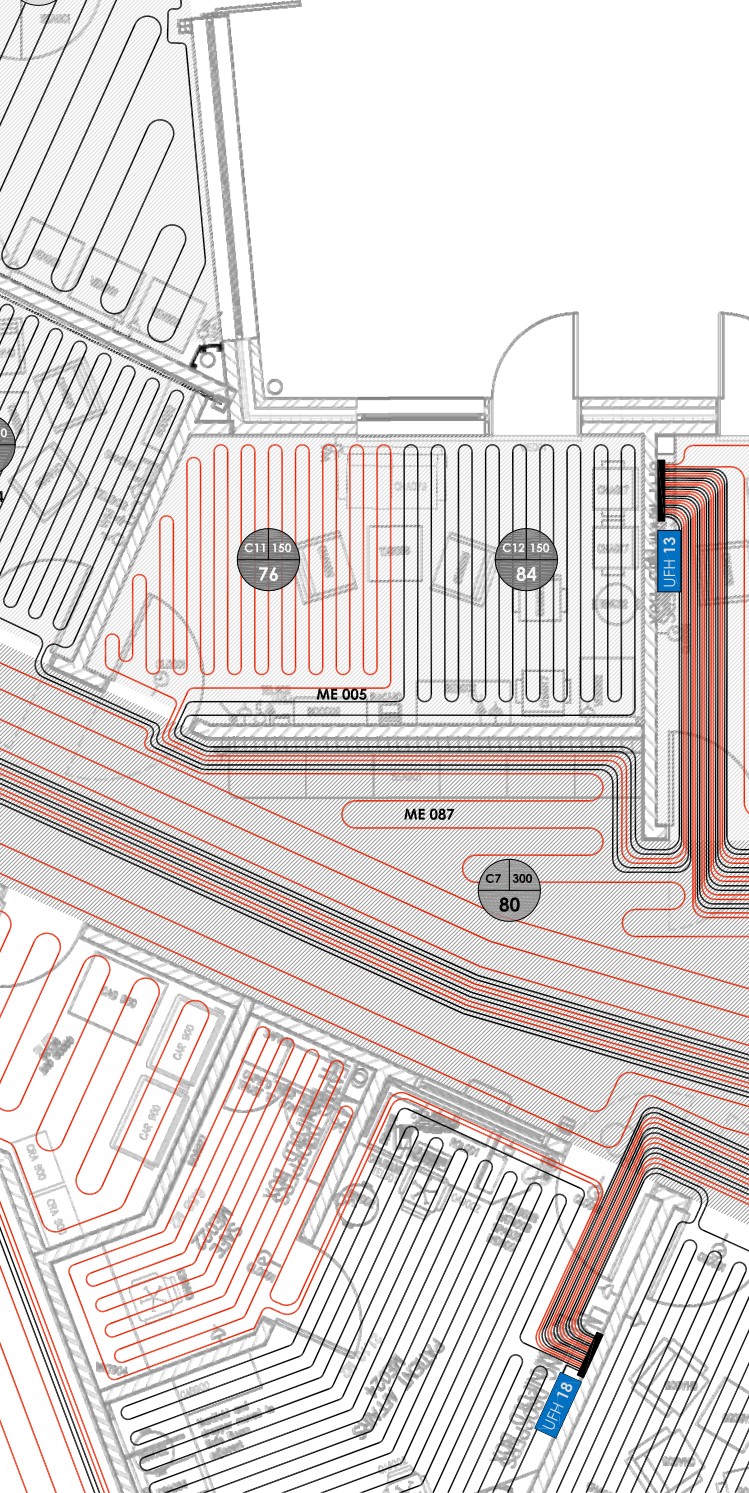

# Warmup<sup>®</sup>

The world's **best-selling** floor heating brand<sup>™</sup>

**Over 2 million installations in  
more than 65 countries**

## Experience MyHeating<sup>™</sup>

Download now for iOS and Android



MyHeating App



### SmartGeo<sup>™</sup>

Automatically at the right temperature. 25% lower energy usage.

### EasySwitch<sup>™</sup>

Always on the best tariff, automatically. Saving on average £210.

### Easy to use

Simple and secure set-up using WiFi with 24/7 technical support.

**Combined Saving of £378 per year**



## 4iE<sup>®</sup> SMART WIFI THERMOSTAT

Warmup Plc  
702 & 704 Tudor Estate  
Abbey Road  
London, NW10 7UW

T: 0345 345 2288  
E: uk@warmup.com  
F: 0345 345 2299  
W: www.warmup.co.uk



Please scan the QR code  
for more information

The WARMUP word and associated logos are trade marks.

©Warmup plc 2016 Reg'd. TM Nos. 1257724, 4409934, 4409926, 5265707. E & OE

v12-11/2016